



**LAVASTOVIGLIE PROFESSIONALI**  
**PROFESSIONAL DISHWASHERS**  
**LAVE-VAISSELLE A USAGE COLLECTIF**  
**PROFESSIONELLER GESCHIRRSPÜLER**  
**LAVAVAJILLAS PROFESIONAL**  
**MÁQUINA DE LAVAR LOUÇA PROFISSIONAL**



**MANUALE D' USO ED INSTALLAZIONE**  
**MANUAL FOR USE AND INSTALLATION**  
**MANUEL D' EMPLOI ET MISE EN PLACE**  
**GEBRAUCHSANWEISUNG UND INSTALLATION**  
**MANUAL DE INSTALACIÓN DE USO**  
**MANUAL DE INSTALAÇÃO USO**

**MODELS – MODELES – MODELLE – MODELLI - MODELOS**

AGB 648/WP	AGB 649/WP
AGB 650/WP	AGB 650/DP
AGB 651/WP	AGB 651/DP
AGB 652/WP	AGB 652/DP
AGB 653/WP	AGB 653/DP
AGB 654/WP	AGB 654/DP
AGB 655/WP	AGB 655/DP
AGB 656/WP	AGB 657/WP
AGB 658/WP	AGB 661/WP
AGB 662/WP	AGB 662/DP
AGB 663/WP	
ADN 408	ADN 409

- 1 Avvertenze per la sicurezza e l'uso**
- 2 Caratteristiche tecniche**
- 3 Installazione e posizionamento**
- 4 istruzioni per l'installatore**
- 5 Prima messa in funzione per l' installatore**
- 6 Istruzioni per l'utente modelli meccanici**
- 7 Manutenzione e pulizia (utente)**
- 8 Problemi ed anomalie (utente)**

Vi ringraziamo per la scelta del prodotto.

Consigliamo di leggere attentamente tutte le istruzioni contenute nel manuale per conoscere le condizioni più idonee per un corretto utilizzo della lavastoviglie.

#### **ISTRUZIONI TECNICHE:**



Sono destinate al personale qualificato che deve eseguire l'installazione, la messa in servizio, il collaudo, ed eventuali interventi di assistenza.

#### **ISTRUZIONI PER L'UTENTE:**

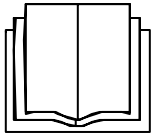

Indicano i consigli d'uso, la descrizione dei comandi e le corrette operazioni di pulizia e manutenzione della lavastoviglie.

QUELLA VAI SULLA .COM

# 1 AVVERTENZE PER LA SICUREZZA E L'USO



**QUESTO MANUALE COSTITUISCE PARTE INTEGRANTE DELLA LAVASTOVIGLIE; OCCORRE CONSERVARLO SEMPRE INTEGRO UNITAMENTE ALL'APPARECCHIO.**



**IL POSIZIONAMENTO, GLI ALLACCIAMENTI, LA MESSA IN FUNZIONE E L'ELIMINAZIONE DI INCONVENIENTI, E LA SOSTITUZIONE DEL CAVO DI ALIMENTAZIONE DEVONO ESSERE ESEGUITI DA PERSONALE QUALIFICATO.**

LA LAVASTOVIGLIE E' DESTINATA ESCLUSIVAMENTE AD USO PROFESSIONALE E DEVE ESSERE UTILIZZATA DA PERSONALE ABILITATO. E' PREDISPOSTA PER IL LAVAGGIO DI STOVIGLIE (PIATTI, TAZZE, CIOTOLE, TEGLIE, POSATE) E SIMILI NEI SETTORI GASTRONOMICI E NEL RAMO DELLA RISTORAZIONE COLLETTIVA, ED E' CONFORME ALLE NORME INTERNAZIONALI DI SICUREZZA ELETTRICA E MECCANICA (CEI-EN-IEC 60335-2-58/61770) E DI COMPATIBILITA' ELETTROMAGNETICA (CEI-IEC-EN 55014-1/2, 61000-3;4, 50366).

IL COSTRUTTORE **DECLINA OGNI RESPONSABILITA'** PER DANNI A PERSONE O COSE CAUSATI **DALL'INOSSERVANZA** DELLE ISTRUZIONI PRESENTI NEL MANUALE, **DALL'USO NON CORRETTO**, DALLA **MANOMISSIONE** ANCHE DI UNA SINGOLA PARTE DELL'APPARECCHIO E DALL'UTILIZZO DI **RICAMBI NON ORIGINALI**.



**E' OBBLIGATORIO IL COLLEGAMENTO DI TERRA** SECONDO LE MODALITA' PREVISTE DALLE NORME DI SICUREZZA DELL'IMPIANTO ELETTRICO.

QUESTO APPARECCHIO E' CONTRASSEGNA TO IN CONFORMITA' ALLA DIRETTIVA EUROPEA **2002/96/EC**, WASTE ELECTRICAL AND ELECTRONIC EQUIPMENT (WEE).

ASSICURANDOSI CHE QUESTO PRODOTTO SIA SMALTITO IN MODO CORRETTO L'UTENTE CONTRIBUISCE A PREVENIRE LE POTENZIALI CONSEGUENZE NEGATIVE PER L'AMBIENTE E LA SALUTE.

IL SIMBOLO  SUL PRODOTTO O SULLA DOCUMENTAZIONE DI ACCOMPAGNAMENTO INDICA CHE QUESTO PRODOTTO NON DEVE ESSERE TRATTATO COME RIFIUTO DOMESTICO MA DEVE ESSERE CONSEGNATO PRESSO L'IDONEO PUNTO DI RACCOLTA PER IL RICICLAGGIO DI APPARECCHIATURE ELETTRICHE ED ELETTRONICHE.

DISMETTERE L'APPARECCHIO SEGUENDO LE NORMATIVE LOCALI PER LO SMALTIMENTO DEI RIFIUTI.

PER ULTERIORI INFORMAZIONI SUL TRATTAMENTO, RECUPERO E RICICLAGGIO DI QUESTO PRODOTTO, CONTATTARE IL COMPETENTE UFFICIO LOCALE, IL SERVIZIO DI RACCOLTA DEI RIFIUTI DOMESTICI O IL NEGOZIO PRESSO IL QUALE IL PRODOTTO E' STATO ACQUISTATO.



NON INTRODURRE SOLVENTI COME ALCOL O TREMENTINA CHE POTREBBERO PROVOCARE UN'ESPLOSIONE. NON INTRODURRE STOVIGLIE SPORCHE DI CENERE, CERA, VERNICI.



NON UTILIZZARE MAI LA LAVASTOVIGLIE O SUE PARTI COME SCALA, SUPPORTO O SOSTEGNO PER PERSONE, COSE O ANIMALI.

APPOGGIARSI O SEDERSI SULLA PORTA APERTA DELLA LAVASTOVIGLIE POTREBBE CAUSARNE IL RIBALTAMENTO, CON CONSEGUENTE PERICOLO PER LE PERSONE.

NON LASCIARE LA PORTA DELLA LAVASTOVIGLIE APERTA IN QUANTO VI SI POTREBBE INCIAMPARE.



NON BERE L'ACQUA RESIDUA EVENTUALMENTE PRESENTE NELLE STOVIGLIE O NELLA LAVASTOVIGLIE AL TERMINE DEL PROGRAMMA DI LAVAGGIO.



L'APPARECCHIO NON E' ADATTO PER L'USO DA PARTE DI MINORI E PERSONE CON RIDOTTE CAPACITA' FISICHE, SENSORIALI O MENTALI, MANCANTI DI ESPERIENZA E CONOSCENZA. L'UTILIZZO DELL'APPARECCHIO E' CONSENTITO A QUESTE PERSONE SOLO SOTTO LA SUPERVISIONE DI UNA PERSONA RESPONSABILE DELLA LORO SICUREZZA.

## 2 CARATTERISTICHE TECNICHE

		ADN408-ADN409	AGB648-AGB649- AGB650-AGB651- AGB652-AGB653- AGB654-AGB655- AGB656	AGB657-AGB658- AGB661-AGB662- AGB663-AGB653- AGB654
Tensione di alimentazione	V	400V/3+N 230V/1	400V/3+N 230V/1	400V/3+N 230V/1
Frequenza	Hz	50	50	50
Potenza max. assorbita	kW	4,9	4,9	5,1 – 6,6
Potenza resistenza boiler	kW	4,5	4,5	4,5 - 6
Potenza resistenza vasca	kW	2,5	2,5	2
Potenza pompa lavaggio	kW	0,4	0,4	0,6
Pressione acqua alimentazione	kPa	200-400	200-400	200-400
Temperatura acqua alimentazione	°C	50 – 60	50 – 60	50 – 60
Temperatura acqua alimentazione versioni "A" (addolcitore incorporato)	°C	15 – 30	15 – 30	15 – 30
Durezza acqua alimentazione	°dF	7 – 12	7 – 12	7 – 12
Consumo acqua per ciclo di risciacquo	l	2,4	2,4	2,4
Capacità boiler	l	7	7	7
Capacità vasca	l	26	26	14,5
Durata cicli standard con alimentazione acqua a 50°C	s	120	120/180	120/180
Livello rumorosità	dB(A)	66	66	66
Grado protezione	IPX	4	4	4
Peso netto	kg	64	64	66
Tipo di cavo di alimentazione	HAR▶	H05VV-F	H05VV-F	H05VV-F

QUELLAVENDETTA.COM

### 3 INSTALLAZIONE E POSIZIONAMENTO



#### INSTALLAZIONE E POSIZIONAMENTO

Portare la lavastoviglie sul luogo di installazione, rimuovere l'imballo, verificare l'integrità dell'apparecchio e dei componenti, in caso di danni questi devono essere notificati per iscritto al trasportatore.

Gli elementi di imballaggio (sacchetti di plastica, polistirolo espanso, chiodi, ecc.) non devono essere lasciati alla portata di bambini ed animali domestici, in quanto potenziali fonti di pericolo.

Tutti i materiali utilizzati per l'imballo sono compatibili con l'ambiente. Essi possono essere conservati senza pericolo, o essere smaltiti presso un apposito centro di smaltimento rifiuti.

I componenti in materiale plastico soggetti ad eventuale smaltimento con riciclaggio sono contrassegnati nei seguenti modi:

PE polietilene: pellicola esterna imballo, sacchetto istruzioni, sacchetti di protezione.

PP polipropilene: reggette.

PS polistirolo espanso: angolari di protezione, coperchio imballo.

I componenti in legno e cartone possono essere smaltiti rispettando le norme vigenti.

Alla dismissione del prodotto evitare di disperderlo nell'ambiente; lo smantellamento deve avvenire nel rispetto delle norme vigenti. Tutte le parti metalliche sono in acciaio inossidabile e smontabili.

Le parti in plastica sono contrassegnate con il simbolo del relativo materiale.

#### POSIZIONAMENTO:



**Attenzione:** l'impianto interno ed i locali in cui vengono installate apparecchiature per comunità, devono rispondere alle normative vigenti.

Il costruttore declina ogni responsabilità per danni diretti o indiretti a persone o cose derivanti dal mancato rispetto di dette normative.

Prima dell'installazione verificare che nelle adiacenze non vi siano o siano adeguatamente protetti, oggetti e materiali che potrebbero essere danneggiati dal vapore acqueo o da schizzi di soluzione di lavaggio.

Posizionare la lavastoviglie nel punto desiderato e togliere la pellicola protettiva.

Livellare la lavastoviglie (aiutandosi con una livella) sui quattro piedini regolati in modo da garantirne la stabilità; ogni altra soluzione deve essere approvata dal costruttore.

### 4 ISTRUZIONI PER L'INSTALLATORE



#### ALLACCIAMENTO IDRAULICO E SCARICO:

I tubi idraulici ed il cavo di alimentazione elettrica fuoriescono dalla zona posteriore. Allacciare il tubo di alimentazione idrica ad una presa con bocca filettata  $\frac{3}{4}$ " **gas**.

Per il collegamento alla rete idrica utilizzare solamente tubi nuovi; tubi vecchi o usati non devono essere utilizzati.

La **pressione** dinamica di alimentazione dovrà essere compresa tra **2 e 4 bar**, se superiore è necessario installare un riduttore di pressione.

E' indispensabile installare un rubinetto generale sulla tubazione di arrivo acqua di alimentazione; il rubinetto dovrà essere accessibile ad installazione terminata, non installare il rubinetto dietro la lavastoviglie.

La durata ciclo dichiarata è riferita ad alimentazione con **acqua calda 50°C**.

In caso di alimentazione ad acqua fredda la durata potrebbe aumentare in relazione alla temperatura dell'acqua in ingresso, essendo la lavastoviglie dotata di risciacquo a temperatura e pressione costanti.

#### SCARICO:

Ogni lavastoviglie è già dotata di tubo per il collegamento allo scarico; questo sarà da prevedersi a pavimento, con piletta a sifoide.



**Attenzione:** accertarsi che i tubi di alimentazione e scarico non siano piegati, strozzati o schiacciati dopo l'installazione.

## 4.1 Allacciamento elettrico

Il collegamento elettrico della lavastoviglie ed eventuali apparecchi supplementari va affidato a personale autorizzato e qualificato, nel rispetto delle norme vigenti; osservare inoltre le disposizioni tecniche di allacciamento.

La potenza totale installata è riportata sulla targhetta dati tecnici dell'apparecchio.

Insieme alla lavastoviglie non devono essere protetti altri apparecchi.

L'esercente dovrà provvedere all'installazione, secondo le norme vigenti, di un interruttore generale sulla linea di alimentazione elettrica e di un interruttore differenziale compatibile con le caratteristiche della macchina.

Tali interruttori devono essere installati vicino alla lavastoviglie, essere facilmente accessibili dopo l'installazione e garantire la disconnessione completa della rete elettrica nelle condizioni della categoria di sovratensione III.



### Attenzione!!!

La lavastoviglie è priva di tensione solamente quando l'interruttore generale è disinserito.

Collegare l'apparecchio al sistema equipotenziale utenza. Il morsetto  per il collegamento è posto nella zona posteriore inferiore della macchina. Il conduttore di protezione (PE) è di colore giallo-verde, il conduttore neutro (N) di colore blu e i conduttori di fase (L1, L2, L3) di colore nero, grigio e marrone.

## 5 PRIMA MESSA IN FUNZIONE ( Installatore )



### PRIMA MESSA IN FUNZIONE

Il sistema elettrico di protezione deve essere sottoposto ad un test funzionale prima della messa in esercizio. L'installazione deve essere eseguita e/o verificata dal rivenditore autorizzato che si occuperà della prima messa in funzione e delle istruzioni relative al funzionamento della lavastoviglie.

### PREPARAZIONE ALL'USO

#### Importante:

Il dosatore brillantante è sempre presente, il dosatore detersivo solamente su alcuni modelli.

**Se entrambi i dosatori sono presenti** posizionare i contenitori esterni di detersivo e brillantante ed inserirvi i rispettivi tubi di pescaggio posti sul retro della macchina.

#### Tubo rosso: detersivo

#### tubo trasparente: brillantante

Prima di introdurre i tubi nei contenitori applicare alle estremità il peso (necessario a mantenere il pescaggio sul fondo del contenitore) ed il filtro come indicato in figura.

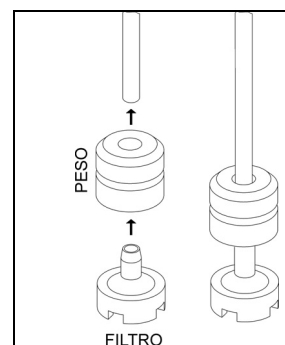
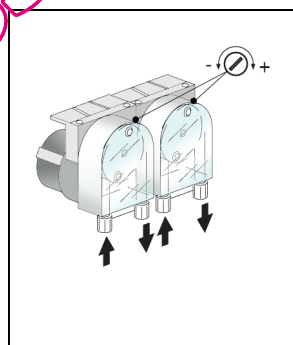

Per la regolazione agire sulle viti di regolazione indicate in figura, si raccomanda di fare eseguire la regolazione dal personale delle società fornitrici di prodotti di detersivi. Se il dosatore detersivo non è premontato, è possibile installarlo successivamente ordinando il KIT relativo.

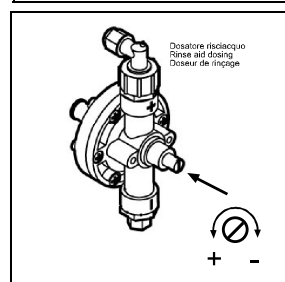

In alternativa è possibile collegare un dosatore esterno eseguendone il collegamento elettrico con un cavo 2x0,5 mm tipo H05 RN-F, inserito attraverso il passaggio indicato nello schema CARATTERISTICHE TECNICHE e collegato come da schema elettrico in dotazione alla lavastoviglie.

Il dosatore deve essere 230V/50 Hz con potenza massima assorbita di **15 W**.

Collegare al dosatore detersivo esterno alla lavastoviglie attraverso il tubo rosso sopraccitato.

## 6 ISTRUZIONI PER L'UTENTE MODELLI MECCANICI

**AGB 648/WP- AGB 650/DP- AGB 650/WP- AGB 654/DP- AGB 654/WP- AGB 656/WP- AGB 657/WP- AGS  
653/WP- AGB 661/DP- AGB 661/WP- AGB 663/WP**



**AGB 649/WP- AGB 651/DP- AGB 651/WP- AGB 655/DP- AGB 658/WP- AGS 654/WP- AGB 662/DP-  
AGB 662/WP**

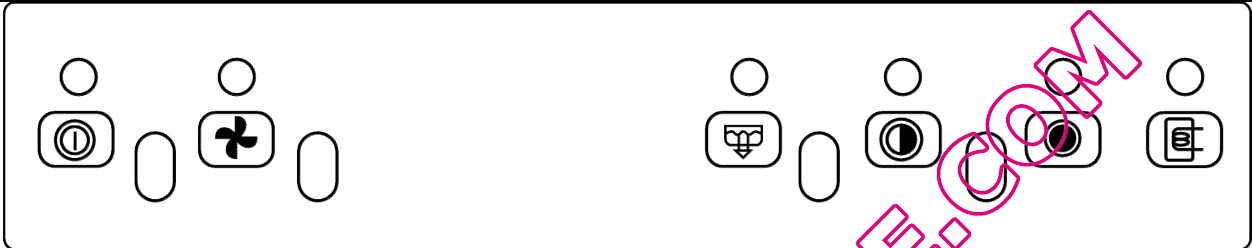

**AGB 653/DP- AGB 653/WP**

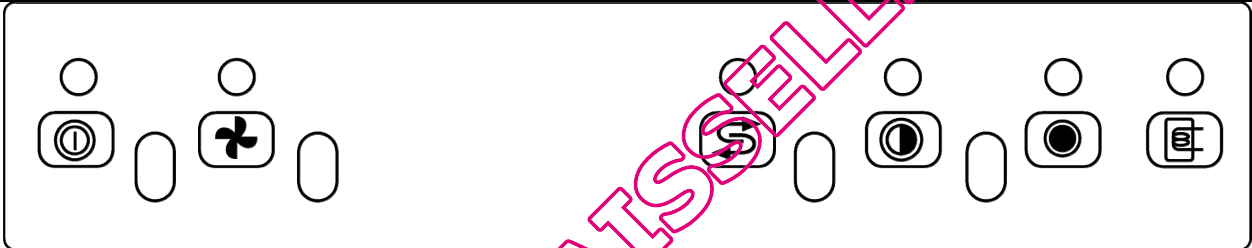

**AGB 652/DP- AGB 652/WP**

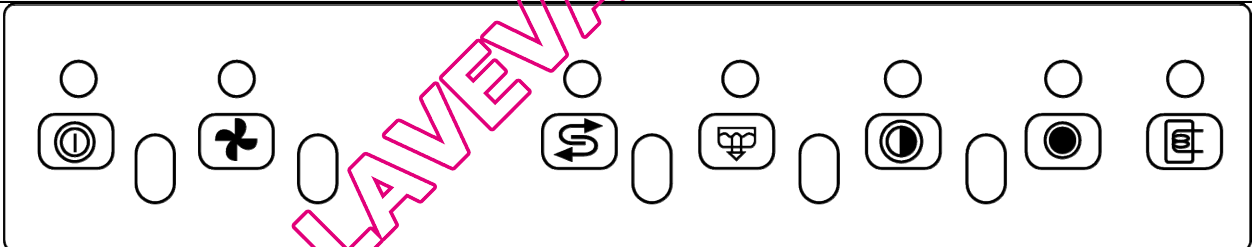



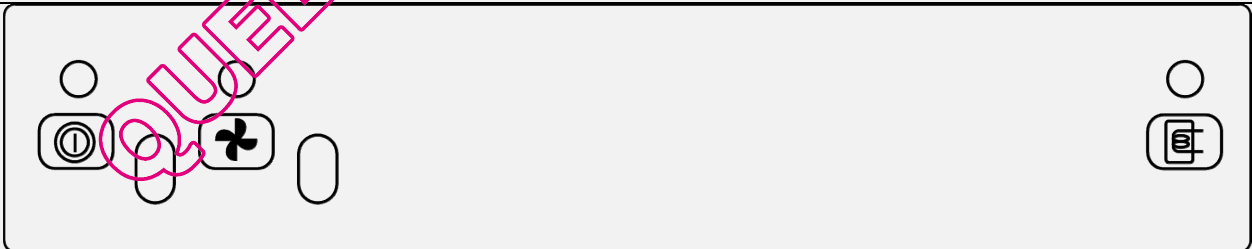



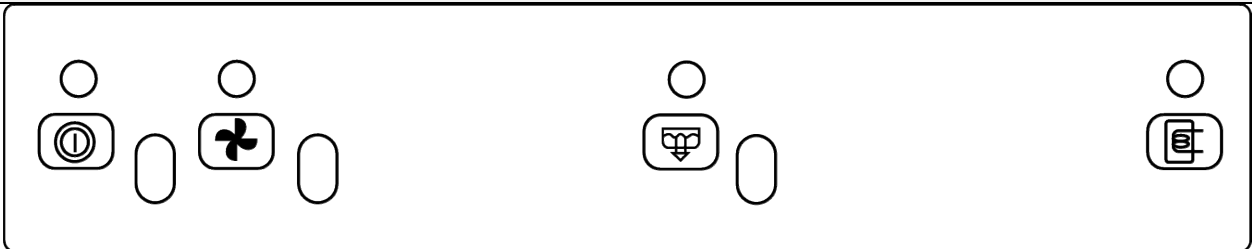

**ADN408**



**ADN409**





	Simbolo pulsante on/off		Lampade spia funzioni
	Simbolo pulsante ciclo lavaggio		Simbolo pulsante pompa scarico
	Simbolo pulsante rigenerazione		Simbolo lampada spia boiler risciacquo
	Simbolo ciclo breve		Simbolo ciclo medio

## 6.1 Prima del lavaggio

Usare solamente detersivi e brillantanti per lavastoviglie industriali.

Non utilizzare detersivi previsti per il lavaggio a mano.



Consigliamo l'utilizzo di prodotti appositamente studiati per questa lavastoviglie.





Durante il rabbocco dei serbatoi fare attenzione a non scambiare i prodotti, questo potrebbe provocare malfunzionamenti e danni alla lavastoviglie.

Non mescolare detersivi diversi, si danneggerebbe il dispositivo dosatore.

I detersivi per lavastoviglie industriali possono provocare gravi irritazioni. Rispettare attentamente le istruzioni del produttore di detersivo riportate sulla confezione.

Aprire il rubinetto di rete dell'acqua (utenza). 	Verificare: Il livello di detersivo e brillantante nei contenitori. 		Inserire l'interruttore generale (utenza), sul display compare "OFF". 
	Il corretto posizionamento dei filtri, la rotazione degli irroratori, l'assenza di corpi estranei nella lavastoviglie.		

## 6.2 Scelta del programma

PROGRAMMA	TIPOLOGIA DI SPORCO	DURATA (*)
	Bicchieri, tazzine, Piatti poco sporchi	Breve circa 120 secondi
	Posate e piatti molto sporchi	Media circa 180 secondi

(\*) La durata cicli sopra indicata si riferisce ad allacciamento trifase, con alimentazione ad acqua calda a 50°C. In caso di alimentazione ad acqua fredda la durata cicli potrebbe aumentare in relazione alla temperatura dell'acqua in ingresso.

## 6.3 Carico delle stoviglie

### Piatti

Il cesto può contenere

**12 piatti fondi** o **18 piatti piani**.

Asportare dai piatti i residui solidi (ossa, bucce, noccioli, ecc.); lasciare preventivamente in ammollo in acqua fredda piatti con residui secchi di formaggio, uovo.....ecc.

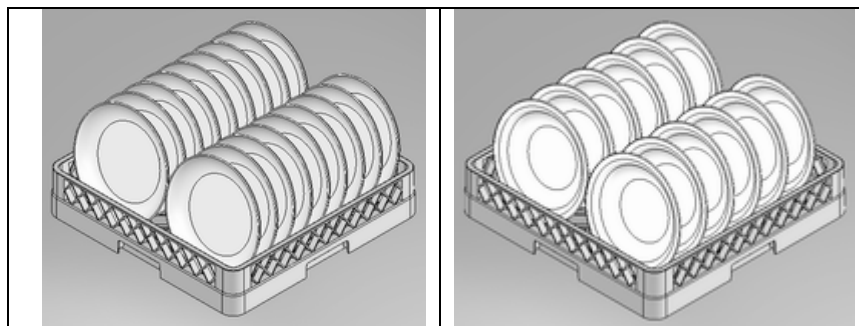

### Bicchieri











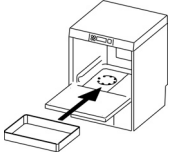
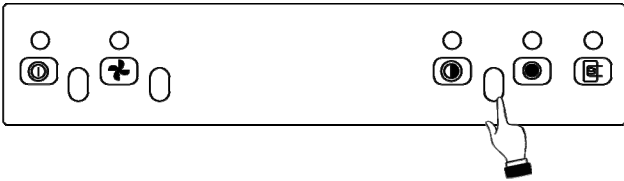

Posizionare i bicchieri rivolti verso il basso.



## Posate

Utilizzare l'apposito/i cestino. Disporre le posate alla rinfusa preferibilmente con il manico rivolto verso il basso, facendo attenzione a non ferirsi con i rebbi delle forchette e le lame dei coltelli.

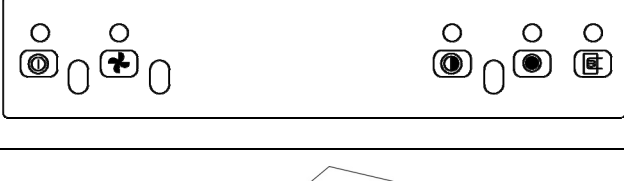
### 6.4 Primo utilizzo giornaliero (vasca e boiler vuoti)

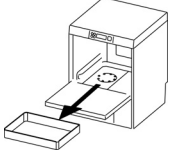
Il pannello visualizzato nel manuale e la grafica potrebbero mostrare funzioni non presenti nella vostra macchina.	Azioni e cosa accade
	<p>Azionare l'interruttore a muro, aprire la porta inserire il troppo pieno, chiudere la porta:</p> <p>Premere il pulsante , si accendono la lampada spia di linea, la lampada spia del ciclo e se presente la lampada spia della pompa scarico; caricamento acqua in boiler ed in vasca.</p> <p>A caricamento boiler e vasca ultimati si accende la lampada spia boiler  e si spegne la lampada spia pompa scarico ( se presente ).</p>
	<p>Caricare il cestello</p>
	<p>Selezionare il programma desiderato ( solo nei modelli con selettore cicli ) premendo:</p> <p> Ciclo breve oppure</p> <p> Ciclo medio</p>
	<p>Attendere che la lampada spia boiler  si spenga. Per avviare il ciclo di lavaggio premere il pulsante ciclo </p>
	<p>Ciclo in corso, la lampada spia ciclo si accende. Se si apre la porta durante il ciclo il programma si arresta, quando viene richiusa il programma si azzerà; per riavviare premere nuovamente il pulsante del ciclo </p>
	<p>A programma terminato la lampada spia ciclo si spegne e si accenderà la lampada spia boiler .</p>
	<p>Scaricare il cestello</p>

## 6.5 Ciclo resine (solo per modelli provvisti di addolcitore acqua)

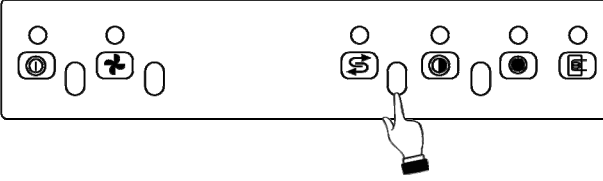
	<p>A macchina spenta aprire la porta e <b>togliere il troppo pieno per svuotare la vasca; una volta svuotata la vasca rimettere il troppo pieno</b> e richiudere la porta.</p> <p>Premere il tasto <b>S</b>: la lampada spia si accende e il ciclo di rigenera parte, dopo 20 minuti il ciclo di rigenera finisce e la macchina rimane spenta. Aprire la porta, verificare che l' acqua di rigenerazione sia in vasca, togliere il troppo pieno per svuotare la vasca; una volta svuotata la vasca rimettere il troppo pieno e richiudere la porta. Disinserire l'interruttore generale a muro.</p>
---	---

Durante l'esecuzione del ciclo di rigenera non sarà possibile eseguire nessuna operazione, va effettuato sempre a vasca vuota.

### Rifornimento sale rigenerante (per modelli provvisti di addolcitore dell'acqua)

Eseguire il rifornimento sale **quando non è presente acqua in vasca** per evitare che acqua di lavaggio entri nel dispositivo addolcitore acqua; estrarre sempre la spina di alimentazione dalla presa di rete prima di eseguire l'operazione. Ricordarsi di rimettere la spina di alimentazione nella presa dopo aver effettuato l'operazione.

### Attenzione: usare solamente sale specifico, non utilizzare sale alimentare

Il serbatoio del sale ha una capacità di circa **1 kg di sale in grani**.

Il serbatoio è situato sul fondo della vasca. Dopo avere estratto il cestello svitare il tappo e versare il sale utilizzando l'imbuto in dotazione. Prima di avvitare nuovamente il tappo rimuovere gli eventuali residui di sale in prossimità dell'apertura.

## 6.6 Scarico totale a fine giornata

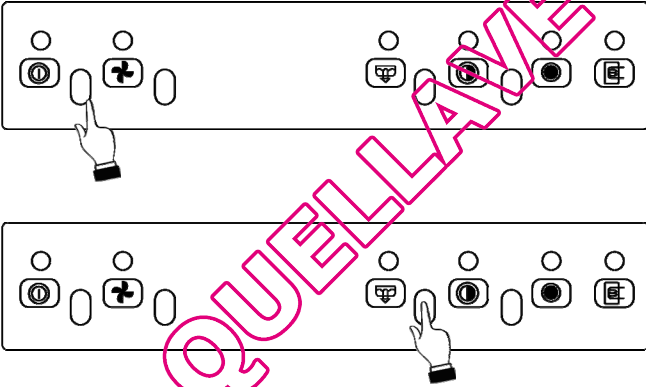
	<p><b>Scarico totale a fine giornata (modelli con pompa scarico)</b></p> <p>Spegnere la macchina premendo il tasto <b>⏻</b>, aprire la porta togliere il troppo pieno, tenere premuto il pulsante pompa scarico <b>P</b> sino al completo svuotamento della vasca.</p> <p>Per rendere nuovamente operativa la macchina è quindi necessario rimettere il troppo pieno in vasca chiudere la porta e premere il tasto <b>on/off</b> <b>⏻</b>, oppure nel caso di fine servizio, disinserire l'interruttore generale a muro.</p> <p><b>Scarico totale a fine giornata (modelli senza pompa scarico)</b></p> <p>Spegnere la macchina premendo il tasto <b>⏻</b>, aprire la porta togliere il troppo pieno, ed attendere il completo svuotamento della vasca. Rimettere il troppo pieno e richiudere la porta. Disinserire l'interruttore generale a muro.</p>
---	--

Non spegnere la lavastoviglie con acqua in vasca, eseguire sempre lo scarico. A fine servizio, dopo aver effettuato lo scarico finale e l'eventuale rigenerazione spegnere la macchina premendo



l'interruttore **⏻**, disinserire l'interruttore a muro e chiudere il rubinetto d'intercettazione acqua. Non lasciare l'apparecchio inattivo acceso ed inutilizzato per periodi di tempo più o meno lunghi.

## 7 MANUTENZIONE E PULIZIA

Nonostante non sia richiesta una particolare manutenzione programmata consigliamo di fare controllare la lavastoviglie da un tecnico specializzato due volte l'anno.

**N.B:** danneggiamenti intenzionali o derivanti da incuria, negligenza, dal mancato rispetto delle prescrizioni, istruzioni e norme o da collegamenti errati, non sono da ritenersi responsabilità del costruttore.

### 7.1 Pulizia quotidiana

La lavastoviglie risponde al grado di protezione **IPX4**, ma è **vietato** utilizzare getti d'acqua diretti per la pulizia.

#### PULIZIA DEL FILTRO DURANTE LA GIORNATA

E' consigliato, in caso di utilizzo particolarmente gravoso, effettuare ogni 30-40 cicli la pulizia del filtro, mantenendo la macchina in condizioni operative; per fare questo eseguire lo "scarico parziale vasca".

Rimuovere i filtri (è sufficiente sollevarli dalla loro sede come indicato in figura), facendo attenzione che residui grossolani non cadano nel pozzetto sotto i filtri, pulirli dai residui e risciacuarli abbondantemente, reinserendoli poi correttamente; non intervenire con oggetti appuntiti o taglienti.

Pulire eventuali incrostazioni di calcare per evitare accumuli;

- Pulire accuratamente e frequentemente le superfici con uno straccio umido; utilizzare detergenti neutri, non abrasivi, non contenenti sostanze a base di cloro, prodotti che corrodono e danneggiano l'acciaio inox.

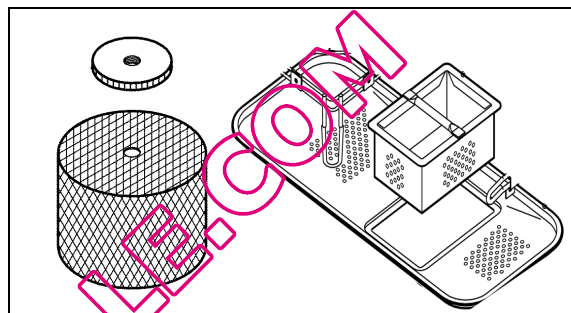

Non utilizzare i prodotti sopra elencati nemmeno per pulire il pavimento sotto la lavastoviglie o nelle vicinanze, per evitare che vapori o gocce possano produrre danni alle superfici in acciaio.

### 7.2 Controlli periodici

Smontare gli irroratori (inferiore e superiore 2-4), svitando la vite centrale (4); svitare i tappi alle due estremità degli irroratori di lavaggio (7).

Pulire i fori e gli ugelli sotto un getto d'acqua corrente pulita, non intervenire con attrezzi che potrebbero provocare danni. Rimontare gli irroratori con cura.

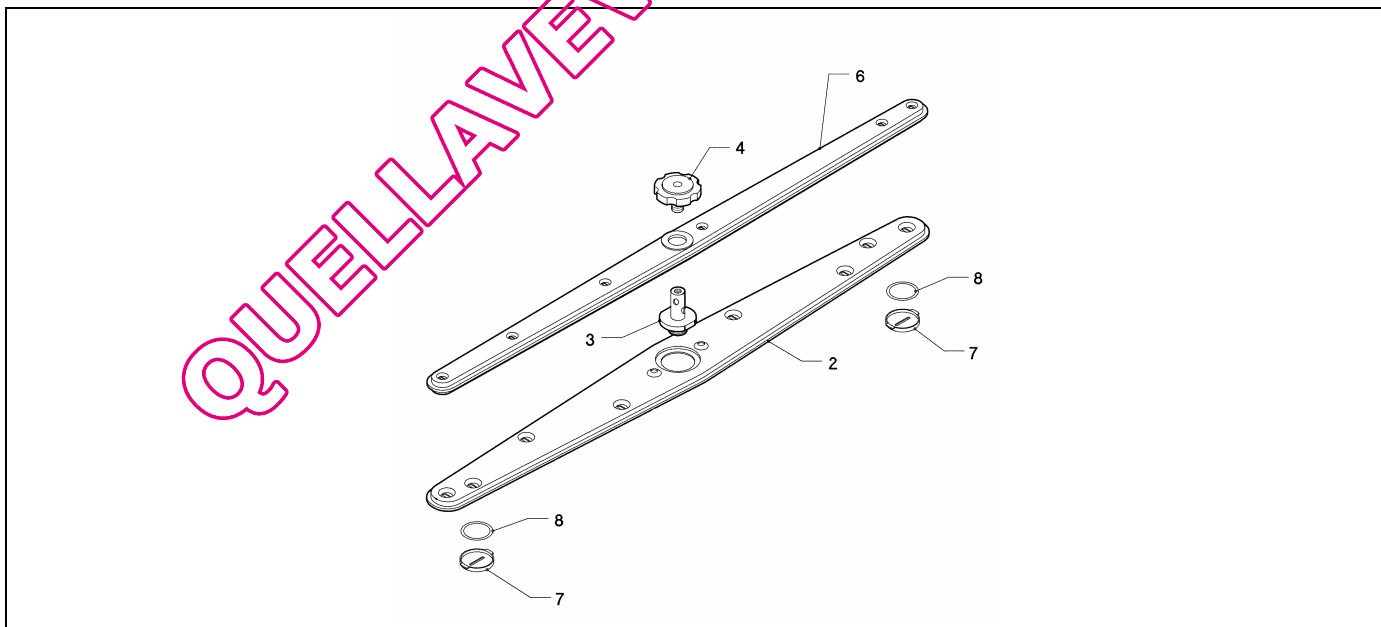

Pulire esternamente la macchina con un panno umido e sapone neutro risciacquando ed asciugando attentamente.

### 7.3 Sosta prolungata

Se si prevede di non utilizzare la lavastoviglie per un periodo di tempo piuttosto lungo, è **necessario eseguire lo svuotamento del dispositivo erogazione di detergente e brillantante per evitare cristallizzazioni e danni alle pompe**: Togliere i tubi di pescaggio dai contenitori del detergente e brillantante ed immergerli in un contenitore contenente di acqua pulita, eseguire alcuni cicli di lavaggio, eseguire scarico completo.

Infine disinserire l'interruttore generale, chiudere il rubinetto d'entrata acqua, I tubi di pescaggio detergente e brillantante andranno nuovamente inseriti nei contenitori al momento della messa in funzione, **facendo attenzione a non invertirli (tubo rosso = detergente; tubo trasparente = brillantante)**.

**Non lasciare l'apparecchio inattivo acceso ed inutilizzato per periodi di tempo più o meno lunghi.**



## 8 PROBLEMI ED ANOMALIE (UTENTE)



PROBLEMA	POSSIBILE CAUSA	POSSIBILE RIMEDIO
NON SI ACCENDE LA SPIA DI LINEA	Manca tensione di rete	Verificare connessione alla rete elettrica.
IL PROGRAMMA DI LAVAGGIO NON SI AVVIA	Il riempimento della lavastoviglie non è ancora terminato.	Attendere che la lampada spia boiler si accenda.
RISULTATI DI LAVAGGIO SCADENTI	Fori di lavaggio degli irroratori intasati o incrostati	Smontare e pulire irroratori (7.2 Controlli periodici)
	Detergente o brillantante insufficiente o non adeguato	Verificare tipo e quantità di detergente.
	Piatti /bicchieri mal posizionati	Disporre adeguatamente piatti/bicchieri.
	Bassa temperatura di lavaggio	Verificare temperatura visualizzata sul display, se inferiore ai 50° chiamare Assistenza.
	Ciclo impostato inadeguato	Aumentare durata ciclo di lavaggio, in particolare se molto sporco o parzialmente essiccato.
RISCIACQUO INSUFFICIENTE	Ugelli irroratori intasati Boiler incrostato di calcare	Verificare pulizia ugelli e se l'addolcitore eventualmente montato funziona correttamente.
BICCHIERI E POSATE MACCHIATI	Brillantante inadeguato o non erogato correttamente. Durezza acqua superiore a 12°dF o molti sali disciolti	Verificare contenitore brillantante e se adeguato al tipo di acqua di rete. Se il problema permane contattare assistenza.
PRESENZA DI ACQUA IN VASCA DOPO LO SCARICO	Tubo di scarico mal posizionato o parzialmente ostruito.	Verificare che il tubo e lo scarico della lavastoviglie non siano ostruiti e che lo scarico non sia posizionato troppo in alto; vedi schema di collegamento.

- 1 Usage and safety warnings**
- 2 Technical characteristics**
- 3 Installation and positioning**
- 4 Installer instructions**
- 5 First startup**
- 6 Mechanical model user instructions**
- 7 Maintenance and cleaning (user)**
- 8 Problems and anomalies (user)**

Thank you for having chosen this product.

We recommend that all of the instructions contained in the manual be read carefully in order to fully understand the most suitable conditions for proper use of the dishwasher.

#### **TECHNICAL INSTRUCTIONS:**



Are intended for qualified personnel who shall perform installation, activation, testing and eventual assistance interventions.

#### **USER INSTRUCTIONS:**



Indicate suggestions for use, description of commands and proper dishwasher cleaning and maintenance.

# 1 USAGE AND SAFETY WARNINGS



**THIS MANUAL CONSTITUTES AN INTEGRAL PART OF THE DISHWASHER; IT MUST ALWAYS BE PRESERVED INTACT, TOGETHER WITH THE MACHINE.**



POSITIONING, CONNECTIONS, ACTIVATION AND TROUBLESHOOTING, AND SUBSTITUTION OF THE POWER CABLE MUST **BE PERFORMED BY QUALIFIED PERSONNEL.**

THE DISHWASHER IS INTENDED EXCLUSIVELY FOR PROFESSIONAL USE AND MUST BE USED BY AUTHORIZED PERSONNEL. IT IS DESIGNED TO WASH DISHES (PLATES, CUPS, BOWLS, TRAYS, SILVERWARE) AND SIMILAR ITEMS USED IN GASTRONOMIC SECTORS AS WELL AS IN THE PUBLIC CATERING BRANCH, AND IN CONFORMITY TO THE INTERNATIONAL ELECTRICAL AND MECHANICAL SAFETY (CEI-EN-IEC 60335-2-58/61770) AND ELECTROMAGNETIC COMPATIBILITY (CEI-IEC-EN 55014-1/-2, 61000-3;4, 50366) NORMS.

THE MANUFACTURER **DECLINES ANY RESPONSIBILITY** FOR DAMAGE TO PERSONS OR THINGS CAUSED **BY FAILURE TO OBSERVE** THE INSTRUCTIONS PRESENT IN THE MANUAL, **INCORRECT USE, TAMPERING**, EVEN WITH A SINGLE PART OF THE MACHINE, AND THE USE OF **NON-ORIGINAL SPARE PARTS**.



**THE GROUNDING CONNECTION**, IN CONFORMITY TO THE METHODS PRESCRIBED BY THE ELECTRICAL SYSTEM'S SAFETY NORMS, **IS OBLIGATORY.**

THIS MACHINE IS MARKED IN CONFORMITY TO THE EUROPEAN DIRECTIVE **2002/96/EC**, WASTE ELECTRICAL AND ELECTRONIC EQUIPMENT (WEE).

ENSURING THAT THIS PRODUCT BE DISPOSED OF IN A PROPER MANNER CONTRIBUTES TO THE PREVENTION OF POTENTIAL NEGATIVE HEALTH AND ENVIRONMENTAL CONSEQUENCES.

THE  SYMBOL UPON THE PRODUCT, OR UPON ITS ACCOMPANYING DOCUMENTATION, INDICATES THAT THIS PRODUCT MAY NOT BE TREATED AS DOMESTIC WASTE, BUT RATHER MUST BE TAKEN TO A COLLECTION FACILITY WHICH IS SUITABLE FOR THE RECYCLING OF ELECTRIC AND ELECTRONIC EQUIPMENT.

DISCARD THIS PRODUCT IN CONFORMITY TO THE LOCAL NORMS REGARDING WASTE DISPOSAL. FOR MORE INFORMATION REGARDING THE TREATMENT, SALVAGE AND RECYCLING OF THIS PRODUCT, CONTACT YOUR COMPETENT LOCAL OFFICES, YOUR LOCAL WASTE COLLECTION SERVICE PROVIDER OR THE POINT OF SALE IN WHICH THE PRODUCT WAS PURCHASED.



DO NOT INSERT SOLVENTS SUCH AS ALCOHOL OR TURPENTINE INTO THE MACHINE, AS THEY COULD CAUSE AN EXPLOSION. DO NOT INSERT DISHES WITH ASH, WAX OR VARNISH RESIDUES INTO THE MACHINE.



NEVER USE THE DISHWASHER OR ITS PARTS AS A STEPLADDER OR SUPPORT FOR PERSONS, THINGS OR ANIMALS.

LEANING OR SITTING UPON THE DISHWASHER'S OPEN DOOR COULD CAUSE IT TO TIP AND POSE A DANGER TO PEOPLE IN THE VICINITY.

IN ORDER TO AVOID TRIPPING UPON IT, DO NOT LEAVE THE DISHWASHER DOOR OPEN.



DO NOT DRINK THE RESIDUAL WATER WHICH MAY BE PRESENT WITHIN THE DISHES OR THE DISHWASHER ITSELF AFTER A WASH CYCLE.



THE MACHINE IS NOT SUITABLE TO BE USED BY MINORS, AND BY PEOPLE WITH REDUCED PHYSICAL, SENSORIAL OR MENTAL CAPABILITIES, WHO LACK THE NECESSARY EXPERIENCE AND KNOWLEDGE FOR ITS PROPER OPERATION. USE OF THE MACHINE IS PERMITTED TO THESE PEOPLE EXCLUSIVELY UNDER THE SUPERVISION OF A PERSON IN CHARGE OF THEIR SAFETY.

## 2 TECHNICAL CHARACTERISTICS

		<b>ADN408- ADN409</b>	<b>AGB648-AGB649- AGB650-AGB651- AGB652-AGB653- AGB654-AGB655- AGB656</b>	<b>AGB657-AGB658- AGB661-AGB662- AGB663-AGB653- AGB654</b>
Power supply	V	400V/3+N 230V/1	400V/3+N 230V/1	400V/3+N 230V/1
Frequency	Hz	50	50	50
Max. power consumed	kW	4,9	4,9	5,1 – 6,6
Boiler element power	kW	4,5	4,5	4,5 - 6
Tank element power	kW	2,5	2,5	2
Wash pump power	kW	0,4	0,4	0,6
Water supply pressure	kPa	200-400	200-400	200-400
Water supply temperature	°C	50 – 60	50 – 60	50 – 60
Version "A" water supply temperature (incorporated water softener)	°C	15 – 30	15 – 30	15 – 30
Water supply hardness	°dF	7 – 12	7 – 12	7 – 12
Water consumption per rinse	l	2,4	2,4	2,4
Boiler capacity	l	7	7	7
Tank capacity	l	26	26	14,5
Standard cycle duration with water supply at 50°C	s	120	120/180	120/180
Noise level	dB(A)	66	66	66
Protection rating	IPX	4	4	4
Net Weight	kg	64	64	66
Power cable type	◀HAR▶	H05VV-F	H05VV-F	H05VV-F

QUELLAVENTASSELLER.COM



### 3 INSTALLATION AND POSITIONING

#### INSTALLATION AND POSITIONING

Bring the dishwasher to its installation location, remove its packaging and verify the integrity of the apparatus and of its components. If damaged, written notification must be sent to the transporter.

The packaging elements (plastic bags, polystyrene foam, nails, etc) must not be left within reach of children and domestic animals as they are a potential source of danger.

All of the materials used for packaging are compatible with the environment. They may be safely preserved, or may be disposed of at an appropriate waste disposal facility.

The components in plastic material subject to eventual disposal through recycling are marked in the following manner:

PE polyethylene: external wrapping, instructions bag, protection bags.

PP polypropylene: straps.

PS polystyrene foam: protective corners, packaging cover.

The wood and cardboard components can be disposed of by respecting the norms in vigor. When disposing of the product, do not abandon it in the environment; its disposal must respect the norms in vigor. All of the metallic parts are in stainless steel and are detachable. The plastic parts are marked with the symbol of the relative material.

#### POSITIONING:



**Warning:** the internal system and the locations in which communal apparatus are to be installed, must answer to the norms in vigor.

The manufacturer declines any responsibility for direct damages to persons or things deriving from lack of respect for the said norms.

Prior to installation, verify that objects and materials which could be damaged by aqueous vapor or by spray from washing solutions are not in the vicinity, or are adequately protected.

Position the dishwasher in the desired position and remove the protective wrapping.

Level the dishwasher (with the help of a level) on its four feet, regulating them in such a way so as to guarantee stability; any alternate solution must be approved by the manufacturer.

### 4 INSTALLER INSTRUCTIONS

#### WATER AND DRAIN CONNECTION:

The water tubes and the electrical power cable stick out from the back of the machine. Connect the water supply tube to a 3/4" threaded **gas** outlet.

Use only new tubes for the connection to the water supply; old or used tubes must not be utilized.

The dynamic **supply pressure** must be between **2 and 4 bar**; if the pressure is higher, a pressure reducer must be installed.

A general faucet must be installed upon the water supply input tubing; the faucet must be accessible after installation has been completed. Do not install the faucet behind the dishwasher.

The declared cycle durations refer to a **50° hot water supply**.

Should a cold water supply be used, the duration of the cycle could increase in relation to the input water temperature, since the dishwasher is equipped with a constant temperature and pressure rinse system.

#### DRAIN:

Every dishwasher comes equipped with a drain connection tube; this tube is intended to be installed at floor level, with a trap drain.



**Caution:** make sure that the supply and drain tubes are not bent, restricted or crushed after installation.



## 4.1 Electrical connection

The dishwasher's electrical connection, and that of eventual supplementary apparatus, is to be entrusted to authorized and qualified personnel, with respect to the norms in vigor; the technical regulations for the connections are also to be observed.

The total power installed is given upon the apparatus' technical data label.

Other apparatus must not be protected together with the dishwasher.

The user must provide for the installation, according to the norms in vigor, of a main electrical power switch and of a differential switch compatible with the machine's characteristics.

These switches must be installed near the dishwasher, be easily accessible after installation and guarantee complete disconnection from the electrical supply in category III over voltage conditions.



### Caution!!!

The dishwasher is free of electrical current only when the main switch is off.

- Connect the apparatus to the usage equalizer. The ⚡ clamp for the connection is located at the lower back of the machine.
- The protection conductor (PE) is yellow-green in color, the neutral conductor (N) is blue and the phase conductors (L1, L2, L3) are black, gray and brown.

## 5 FIRST STARTUP ( Installer )

### FIRST STARTUP

The electrical protection system must be subjected to a functional test before use. The installation must be performed and/or verified by the authorized reseller who will be responsible for the first startup and for the instructions relative to the dishwasher's operation.

### PREPARATION FOR USE

#### Important:

The rinse-aid metering unit comes equipped in all models while the detergent metering unit comes equipped in only some models.

**If both metering units are present**, position the external detergent and rinse-aid containers and insert their respective suction tubes located at the back of the machine.

Red tube: detergent

Transparent tube: rinse-aid

Before inserting the tubes into the containers, apply the weights (necessary to keep the tubes at the bottom of the container) and the filters as indicated in the diagram.

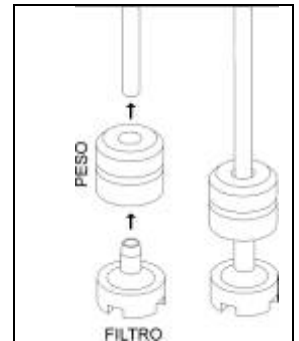
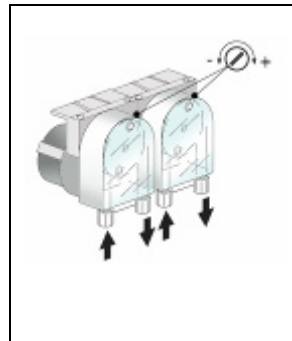

For adjustments, use the adjustment screws indicated in the diagram. It is recommended that adjustments be performed by personnel from the companies who have supplied the detergent products.

If the detergent metering unit did not come pre-installed, it can be installed at a later time by ordering the relative KIT.

Alternatively, an external metering unit can be connected by means of an electrical connection with a 2x0.5 mm type H05 RN-F cable. This cable must be inserted through the passage indicated in the TECHNICAL CHARACTERISTICS scheme and connected in accordance with the electrical scheme furnished with the dishwasher.

The metering unit must be 230V/50Hz with a maximum absorbed power of **15W**.

Connect the external detergent metering unit to the dishwasher through the red tube cited above.

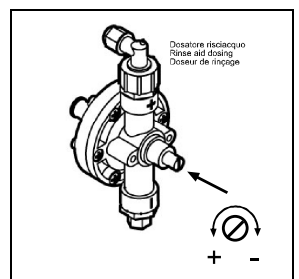

## 6 MECHANICAL MODEL USER INSTRUCTIONS

AGB 648/WP- AGB 650/DP- AGB 650/WP- AGB 654/DP- AGB 654/WP- AGB 656/WP- AGB 657/WP- AGS 653/WP- AGB 661/DP- AGB 661/WP- AGB 663/WP

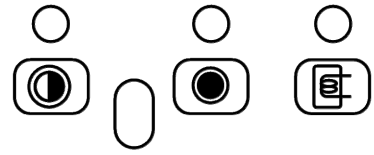
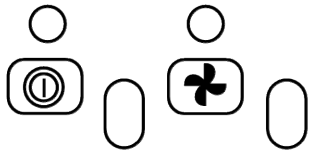

AGB 649/WP- AGB 651/DP- AGB 651/WP- AGB 655/DP- AGB 658/WP- AGS 654/WP- AGB 662/DP- AGB 662/WP

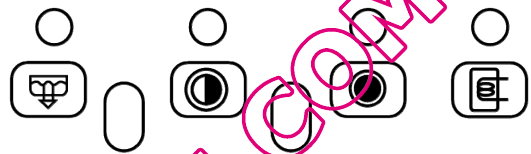
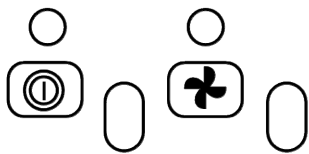

AGB 653/DP- AGB 653/WP

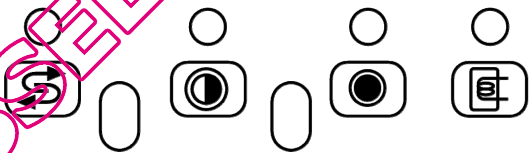
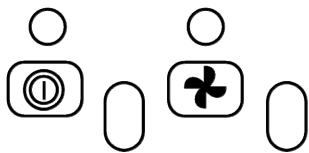

AGB 652/DP- AGB 652/WP

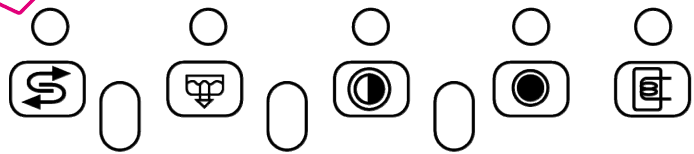
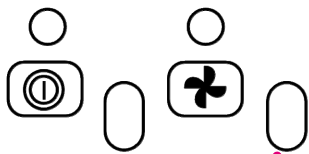



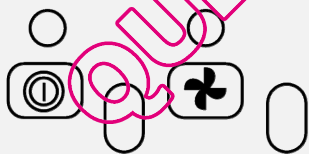



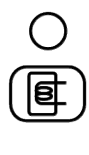
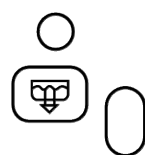
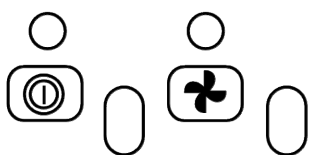

ADN408



ADN409



	on/off button symbol		Led indicator light functions
	Wash cycle button symbol		Drain pump button symbol
	Regeneration button symbol		Boiler rinse led indicator light symbol
	Short wash cycle symbol		Medium wash cycle symbol

## 6.1 Before washing

Use only detergents and rinse-aids for industrial dishwashers.

Do not use detergents intended for hand washing.



It is recommended to use products which were designed especially for this dishwasher.



During the loading of the tanks, be careful not to switch products as this could provoke dishwasher malfunction and damage.

Do not mix different detergents together as this could damage the metering unit.

Detergents for industrial dishwashers can cause serious irritations. Take care to respect the instructions provided by the detergent manufacturer on the packaging.

Open the water supply faucet (usage).	Verify:		Turn off the main switch (usage), "OFF" appears on the display.
	The levels of detergent and rinse-aid in the containers.	The correct positioning of the filters, the rotation of the sprinklers, the absence of foreign objects within the dishwasher.	
			

## DISH LOADING

### Plates

The basket can contain **12 bowls** or **18 flat plates**.

Remove solid residues from the dishes (bones, peels, cores, etc.), before washing, let dishes with residues of dried-on cheese, egg... etc. soak in cold water.

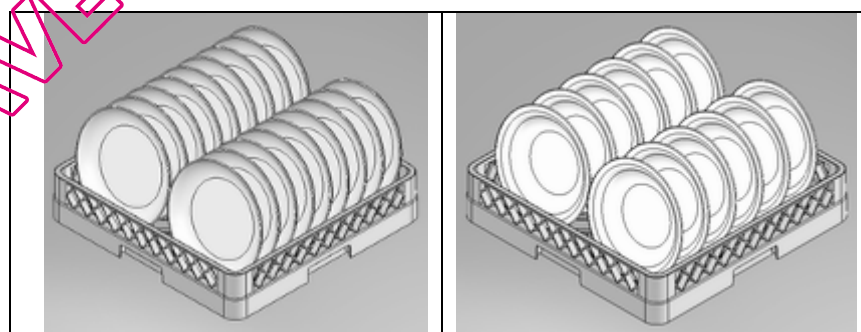

### LOADING GLASSES:

Remove eventual solid residues from the glasses (peels, cores, etc.).











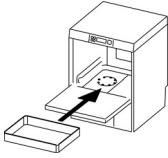
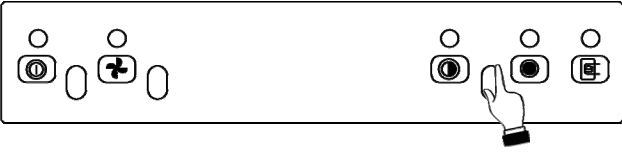

Position the glasses upside down.

### SILVERWARE

Use the appropriate basket. It is preferable to arrange large amounts of silverware with the handles facing down, taking care to avoid injury from fork prongs and knife blades.

## 6.2 First daily use (tank and boiler empty)

The panel shown in the manual and in the graphics may contain functions which are not	What to do and what happens
---	-----------------------------

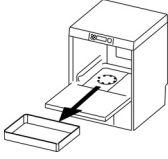
<p><b>present on your machine.</b></p> 	<p>Activate the wall switch, open the door, insert the overflow and close the door:</p> <p>Press the <b>on/off</b>  button. The boiler and tank water-loading led indicator light turns on. Once the boiler and tank have been loaded, the boiler led indicator light  turns on.</p>
	<p>Insert the rack</p>
	<p>Select the desired program by pressing:</p> <p> short cycle or   medium cycle</p>
	<p>Wait for the boiler led indicator light  to turn off</p> <p>To start the wash cycle, press the  cycle button</p>
	<p>Once the cycle has started, the wash cycle led indicator light turns on. If the door is opened during the cycle, the program stops. Once the door has been closed again, the program resets itself; to restart the cycle, press the  cycle button.</p>
	<p>Once the program has finished, the wash cycle led indicator light turns off and the boiler led indicator light  turns on.</p>
	<p>Remove the rack</p>

### 6.3 Resin cycle (only for models equipped with water softeners)

	<p>With the machine off, open the door and <b>remove the overflow in order to empty the tank; once the tank has been emptied, replace the overflow</b> and close the door.</p> <p>Press the <b>S</b> button: the led indicator light turns on and the regeneration cycle starts. After about 20 minutes, the regeneration cycle finishes and the machine shuts off. Open the door, verify that the regeneration water is in the tank and remove the overflow to empty the tank; once the tank has been emptied, replace the overflow and close the door. Deactivate the general wall switch.</p>
--	--

During the execution of the regeneration cycle, it will not be possible to perform any operations. This cycle must always be performed with the tank empty.

#### Refilling the supply of regenerating salt (for models equipped with water softeners)

Perform the salt refill **when there is no water in the tank** in order to keep wash water from entering the water softener device; always unplug the power cable from the socket before performing the operation. Remember to plug the power cable back into the socket after having performed the operation.

**Caution: Use only specific salt. Do not use table salt.**

The salt tank has a capacity of about **1 kg of granulated salt**.

The salt tank is situated at the bottom of the wash tank. After having extracted the rack, unscrew the cap and pour the salt through the provided funnel. Before screwing the cap back in place, remove any eventual salt residues in proximity to the opening.

### 6.4 Total drainage at the end of the day

	<p><b>Total drainage at the end of the day (models with drain pump)</b></p> <p>Turn the machine off by pressing the <b>on/off</b> <b>I</b> button, open the door, remove the overflow and hold down the drain pump button <b>P</b> until the tank has been emptied.</p> <p>In order to reactivate the machine it is therefore necessary to place the overflow back into the tank, close the door and press the <b>on/off</b> <b>I</b> button. Otherwise, if finished using the machine, deactivate the general wall switch.</p> <p><b>Total drainage at the end of the day (models without drain pump)</b></p> <p>Turn the machine off by pressing the <b>on/off</b> <b>I</b> button, open the door, remove the overflow and wait for the tank to empty. Place the overflow back into the tank and close the door. Deactivate the general wall switch.</p>
--	--



Do not turn off the dishwasher while water is still in the tank. Always drain it first. When finished using the machine, after having performed the final drainage and eventual regeneration, turn the machine off

by pressing the **on/off** **I** button, deactivate the wall switch and turn off the water interception faucet. Do not leave the machine on, inactive and unutilized for long periods of time.



## 7 MAINTENANCE AND CLEANING

Although special, programmed maintenance is not required, we recommend having the dishwasher checked by a specialized technician twice a year.

**Note:** intentional damage or that derived from carelessness, negligence, lack of respect for the regulations, instructions and norms or erred connections are not to be considered the responsibility of the manufacturer.

### 7.1 Daily cleaning

The dishwasher has an **IPX4** protection rating, but the use of direct streams of water for its cleaning is **forbidden**.

#### CLEANING OF THE FILTER DURING THE DAY

In case of particularly heavy usage it is recommended to perform a cleaning of the filter every 30-40 wash cycles in order to maintain the machine in operative condition; Use "partial tank draining" in order to perform these cleanings.

Remove the filters (it is sufficient to lift them out of their lodgings as shown in the figure), making sure that greasy residues do not fall into the opening underneath the filters. Clean away the residues and rinse the filters abundantly before correctly reinserting them; Do not utilize pointy or sharp objects for cleaning.

Be sure to remove eventual hardened calcium deposits in order to avoid their accumulation;

- Clean the surfaces well and frequently with a damp rag; use neutral, non-abrasive detergents which do not contain chlorine-based substances or products which can corrode and damage stainless steel.

In order to avoid drops or vapors damaging the steel surfaces, do not even use the above-indicated products for the cleaning of the flooring beneath or around the dishwasher.

### 7.2 Periodic checks

Disassemble the sprinklers (lower and upper 2-4) by removing the central screw (4); unscrew the caps at the two far ends of the rinsing sprinklers (7).

Clean the holes and the nozzles under a stream of clean water. Do not use utensils which could cause damage. Carefully reassemble the sprinklers.

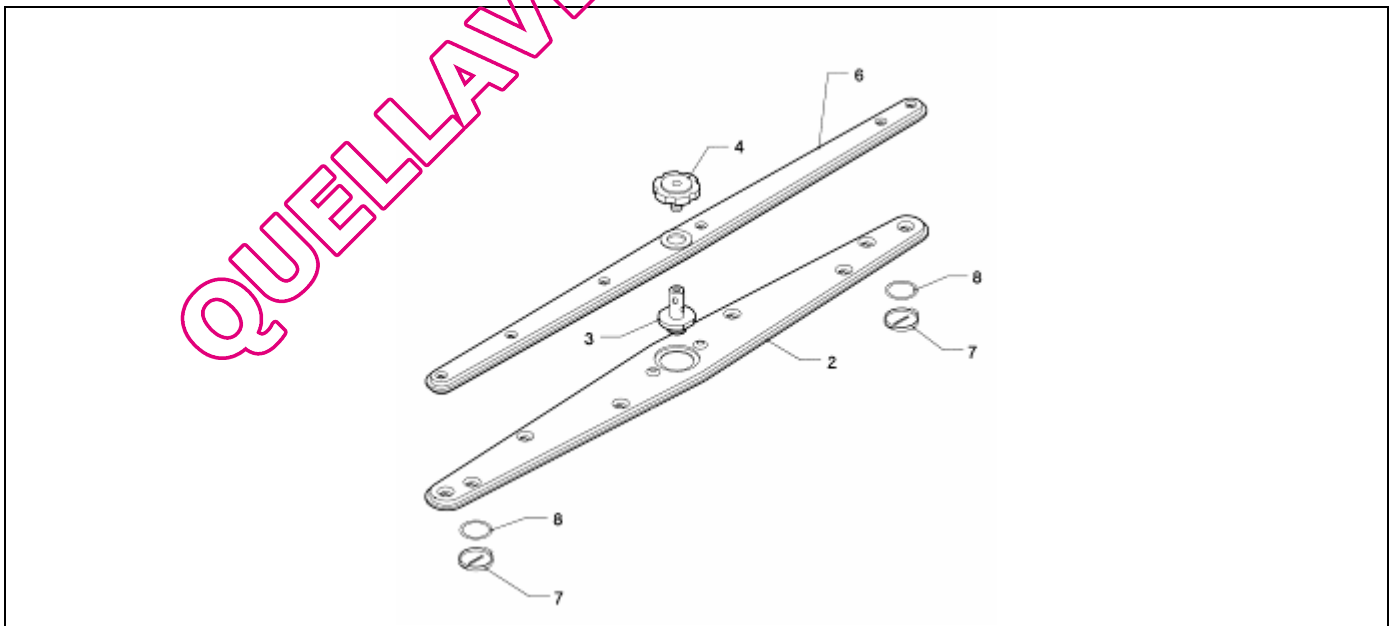
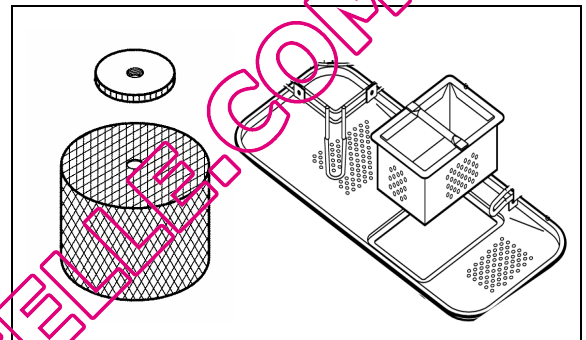

Clean the outside of the machine with neutral soap and a damp cloth. Rinse and dry with care.



### 7.3 Prolonged disuse

If the use of the dishwasher is not foreseen for a relatively long period of time, **it is necessary to drain the detergent and rinse-aid dispenser in order to avoid crystallization and pump damage:** Remove the suction tubes from the detergent and rinse-aid containers and immerse them in a container filled with clean water. Perform a few wash cycles and drain the machine completely.

Finally, turn off the main switch and close the water supply faucet. The detergent and rinse-aid suction tubes will be placed back in the containers when the machine is ready to be put back in use, **taking care so as not to invert the tubes (red tube = detergent; transparent tube = rinse-aid).**

**Do not leave the device on, inactive and unutilized for long periods of time.**



## 8 PROBLEMS AND ANOMALIES (USER)



PROBLEM	POSSIBLE CAUSE	POSSIBLE REMEDY
THE LINE LED INDICATOR DOES NOT TURN ON	There is no electrical current	Verify the electrical current connection.
THE WASH PROGRAM DOES NOT START	The dishwasher has not finished loading	Wait for the boiler led indicator light to turn on.
POOR WASHING RESULTS	Sprinkler wash holes are clogged or encrusted	Disassemble and clean the sprinklers (10.2 Periodic checks)
	Detergent or rinse-aid insufficient or not adequate	Verify detergent type and quantity.
	Plates / glasses poorly positioned	Arrange plates / glasses accordingly.
	Low wash temperature	Verify the temperature shown on the display, if below 50°C call Assistance.
	Inadequate cycle setting	Increase the duration of the wash cycle, particularly if dishes are very dirty or contain partially dried residues.
RINSE INSUFFICIENT	Sprinkler nozzles clogged Calcium encrustations in the boiler	Verify the cleanliness of the nozzles and the correct function of any installed water softeners.
GLASSES AND SILVERWARE ARE STAINED	Rinse-aid inadequate or not dispensed correctly. Water is of a hardness level above 12°dF or contains many dissolved salts	Verify the rinse-aid container and ensure its adequacy for use with the water supply. If the problem persists contact assistance.
WATER IS PRESENT IN THE TANK AFTER DRAINING	Drainage tube is positioned poorly or is partially blocked	Verify that the dishwasher's tube and drain are not blocked and that the drain is not in too high of a position; see the connection diagram.

- 1 Avertissements concernant la sécurité et l'utilisation**
- 2 Caractéristiques techniques**
- 3 Installation et mise en place**
- 4 Instructions pour l'installateur**
- 5 Première mise en service pour l'installateur**
- 6 Instructions pour l'utilisateur modèles mécaniques**
- 7 Entretien et nettoyage (utilisateur)**
- 8 Problèmes et anomalies (utilisateur)**

Nous vous remercions d'avoir choisi l'un de nos produits.  
Nous vous conseillons de lire attentivement toutes les instructions contenues dans la présente notice afin de connaître les conditions les plus appropriées pour une utilisation correcte du lave-vaisselle.

#### **INSTRUCTIONS TECHNIQUES :**



Elles sont destinées au personnel qualifié qui doit effectuer l'installation, la mise en service, le contrôle définitif ainsi que les éventuelles interventions d'assistance.

#### **INSTRUCTIONS POUR L'UTILISATEUR :**

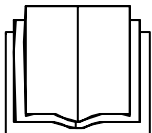

Elles reportent les conseils d'utilisation, la description des commandes et les opérations correctes de nettoyage et d'entretien du lave-vaisselle.

# 1 AVERTISSEMENTS CONCERNANT LA SECURITE ET L'UTILISATION



**LA PRESENTE NOTICE EST PARTIE INTEGRANTE DU LAVE-VAISSELLE ; IL FAUT TOUJOURS LA CONSERVER SOIGNEUSEMENT A PROXIMITE DE L'APPAREIL.**



**LA MISE EN PLACE, LES RACCORDEMENTS, LA MISE EN SERVICE, L'ELIMINATION DES INCONVENIENTS ET LE REMPLACEMENT DU CABLE D'ALIMENTATION DOIVENT ETRE EXECUTES PAR UN PERSONNEL QUALIFIE.**

LE LAVE-VAISSELLE EST EXCLUSIVEMENT DESTINE A UN USAGE COLLECTIF ET IL DOIT ETRE UTILISE PAR UN PERSONNEL AUTORISE. IL EST PREVU POUR LE LAVAGE DE LA VAISSELLE (ASSIETTES, TASSES, BOLS, PLATS, COUVERTS) ET SIMILAIRES DANS LE SECTEUR DE LA GASTRONOMIE ET DE LA RESTAURATION COLLECTIVE. IL EST CONFORME AUX NORMES INTERNATIONALES DE SECURITE ELECTRIQUE ET MECANIQUE (**CEI-EN-IEC 60335-2-58/61770**) ET DE COMPATIBILITE ELECTROMAGNETIQUE (**CEI-IEC-EN 55014-1/-2, 61000-3;4, 50366**).

LE FABRICANT **DECLINE TOUTE RESPONSABILITE** RELATIVE AUX DOMMAGES CAUSES AUX PERSONNES OU AUX CHOSES ET DUS AU **NON RESPECT** DES INSTRUCTIONS CONTENUES DANS LA PRESENTE NOTICE, A UNE **UTILISATION IMPROPRE**, A L'**ALTERATION** NE SERAIT-CE QUE D'UNE SEULE PARTIE DE L'APPAREIL ET A L'UTILISATION DE **PIECES DE RECHANGE NON ORIGINALES**.



**LA CONNEXION DE TERRE** SELON LES MODALITES PREVUES PAR LES NORMES DE SECURITE DE L'INSTALLATION ELECTRIQUE EST **OBIGATOIRE**. SI LE CABLE D'ALIMENTATION EST ENDOMMAGE IL DOIT ETRE REMPLACE PAR LE FABRICANT, SON SERVICE APRES VENTE OU DES PERSONNES DE QUALIFICATION SIMILAIR AFIN D'EVITER UN DANGER

CET APPAREIL EST MARQUE CONFORMEMENT A LA DIRECTIVE EUROPEENNE **2002/96/EC**, WASTE ELECTRICAL AND ELECTRONIC EQUIPMENT (WEE). EN ASSURANT L'ELIMINATION CORRECTE DE CE PRODUIT, L'UTILISATEUR CONTRIBUE A PREVENIR LES CONSEQUENCES NEGATIVES POTENTIELLES POUR L'ENVIRONNEMENT ET LA SANTE.

LE SYMBOLE  PRESENT SUR L'APPAREIL OU DANS LA DOCUMENTATION QUI L'ACCOMPAGNE INDIQUE QUE CE PRODUIT NE DOIT PAS ETRE TRAITE COMME UNE ORDURE MENAGERE MAIS QU'IL DOIT ETRE REMIS A UN CENTRE DE COLLECTE APPROPRIE POUR LE RECYCLAGE DES APPAREILS ELECTRIQUES ET ELECTRONIQUES.

ELIMINER L'APPAREIL CONFORMEMENT AUX REGLEMENTATIONS LOCALES CONCERNANT LE TRAITEMENT DES DECHETS. POUR TOUTE AUTRE INFORMATION CONCERNANT LE TRAITEMENT, LA RECUPERATION ET LE RECYCLAGE DE CE PRODUIT, S'ADRESSER AU SERVICE LOCAL COMPETENT DE COLLECTE DES ORDURES MENAGERES OU LE MAGASIN DANS LEQUEL LE PRODUIT A ETE ACHETE.



NE PAS INTRODUIRE DE SOLVANTS TELS QUE L'ALCOOL OU LA TERE BENTHINE QUI POURRAIENT PROVOQUER UNE EXPLOSION. NE PAS INTRODUIRE DE VAISSELLE SALE DE CENDRE, CIRE OU VERNIS.



NE JAMAIS UTILISER LE LAVE-VAISSELLE OU SES PARTIES COMME ECHELLE, SUPPORT OU SOUTIEN POUR LES PERSONNES, CHOSES OU ANIMAUX.

LE FAT DE S'APPUYER OU DE S'ASSEOIR SUR LA PORTE OUVERTE DU LAVE-VAISSELLE POURRAIT ENTRAINER LE BASCULEMENT DE CE DERNIER ET DONC UN GRAVE DANGER POUR LES PERSONNES.

NE JAMAIS LAISSER LA PORTE DU LAVE-VAISSELLE OUVERTE CAR ELLE POURRAIT CAUSER UN RISQUE DE TREBUCHEMENT



NE PAS BOIRE L'EAU RESIDUELLE EVENTUELLEMENT PRESENTE DANS LA VAISSELLE OU DANS LE LAVE-VAISSELLE A LA FIN DU PROGRAMME DE LAVAGE.



L'APPAREIL N'EST PAS PREVU POUR ETRE UTILISE PAR DES MINEURS OU DES PERSONNES AYANT DES CAPACITES PHYSIQUES, SENSORIELLES OU MENTALES REDUITES, MANQUANT D'EXPERIENCE ET DE CONNAISSANCE. L'UTILISATION DE L'APPAREIL EST AUTORISE A CES PERSONNES EXCLUSIVEMENT SOUS LA SURVEILLANCE D'UNE PERSONNE RESPONSABLE DE LEUR SECURITE

## 2 CARACTERISTIQUES TECHNIQUES

		<b>ADN408- ADN409</b>	<b>AGB648-AGB649- AGB650-AGB651- AGB652-AGB653- AGB654-AGB655- AGB656</b>	<b>AGB657-AGB658- AGB661-AGB662- AGB663-AGB653- AGB654</b>
Tension d'alimentation	V	400V/3+N 230V/1	400V/3+N 230V/1	400V/3+N 230V/1
Fréquence	Hz	50	50	50
Puissance max. absorbée	kW	4,9	4,9	5,1 – 6,6
Puissance résistance du boiler	kW	4,5	4,5	4,5 - 6
Puissance résistance de la cuve	kW	2,5	2,5	2
Puissance pompe de lavage	kW	0,4	0,4	0,6
Pression eau d'alimentation	kPa	200-400	200-400	200-400
Température eau d'alimentation	°C	50 – 60	50 – 60	50 – 60
Température eau d'alimentation versions "A" (adoucisseur incorporé)	°C	15 – 30	15 – 30	15 – 30
Dureté eau d'alimentation	°dF	7 – 12	7 – 12	7 – 12
Consommation d'eau pour cycle de rinçage	l	2,4	2,4	2,4
Capacité du boiler	l	7	7	7
Capacité de la cuve	l	26	26	14,5
Durée des cycles standard avec alimentation d'eau à 50°C	s	120	120/180	120/180
Niveau sonore	dB(A)	66	66	66
Degré de protection	IPX	4	4	4
Poids net	kg	64	64	66
Type de câble d'alimentation	◀HAR▶	H05VV-F	H05VV-F	H05VV-F

QUELLAVENDELSSELLE.COM

### 3 INSTALLATION ET MISE EN PLACE

#### INSTALLATION ET MISE EN PLACE

Transporter le lave-vaisselle sur le lieu d'installation, enlever l'emballage, vérifier l'intégralité de l'appareil et de ses composants. En cas de dommages, ceux-ci doivent être notifiés par écrit au transporteur.

Les éléments d'emballage (sachets en plastiques, mousse de polystyrène, clous, etc.) ne doivent pas être laissés à la portée des enfants ni des animaux domestiques car ils représentent des sources potentielles de danger.

Tous les matériaux utilisés pour l'emballage sont compatibles avec l'environnement. Ils peuvent être conservés sans danger ou être éliminés dans un centre spécialisé de collecte des déchets.

Les éléments en plastique sujets à un éventuel recyclage sont regroupés de la façon suivante :

PE polyéthylène : pellicule extérieure emballage, sachet notice d'emploi, sachets de protection.

PP polypropylène : feuillets.

PS mousse de polystyrène : coins de protection, couvercle emballage.

Les éléments en bois et en carton doivent être éliminés conformément aux normes en vigueur.

En cas d'élimination du produit, éviter de le jeter dans la nature ; la démolition doit avoir lieu conformément aux normes en vigueur. Toutes les parties métalliques sont en acier inoxydable et démontables.

Les parties en plastique reportent le symbole du matériau correspondant.

#### MISE EN PLACE :



**Attention :** L'installation interne ainsi que les locaux dans lesquels sont installés les appareils pour les collectivités doivent être conformes aux normes en vigueur.

Le constructeur décline toute responsabilité relative aux dommages directs ou indirects aux personnes ou aux choses dérivant du non respect desdites normes.

Avant l'installation vérifier l'absence à proximité de l'appareil ou la protection adéquate d'objets ou de matériels susceptibles d'être endommagés par la vapeur d'eau ou par des éclaboussures de produit de lavage.

Positionner le lave-vaisselle à l'endroit souhaité et enlever la pellicule de protection.

Mettre à niveau le lave-vaisselle (à l'aide d'un niveau) sur les quatre pieds réglés de manière à garantir sa stabilité ; toute autre solution doit être approuvée par le constructeur.

### 4 INSTRUCTIONS POUR L'INSTALLATEUR

#### RACCORDEMENT HYDRAULIQUE ET EVACUATION :

Les tuyaux hydrauliques et le câble d'alimentation électrique sortent à l'arrière de l'appareil. Raccorder le tuyau d'alimentation d'eau à une prise à orifice fileté 3/4" gaz.

Pour le raccordement au réseau d'amenée d'eau, utiliser exclusivement des tuyaux neufs ; ne pas utiliser de vieux tuyaux ou des tuyaux ayant déjà servi.

La **pression** dynamique **d'alimentation** devra être comprise entre **2 et 4 bars**, si elle est supérieure il faut installer un réducteur de pression.

Il faut absolument installer un robinet général sur la conduite d'amenée d'eau d'alimentation ; le robinet devra être accessible une fois que l'installation est terminée, ne pas installer le robinet derrière le lave-vaisselle.

La durée des cycles déclarée se réfère à une alimentation à l'**eau chaude à 50°C**.

En cas d'alimentation à l'eau froide, la durée pourrait augmenter en fonction de la température de l'eau en entrée, le lave-vaisselle prévoyant un rinçage à température et à pression constantes.

#### EVACUATION :

Tout lave-vaisselle est muni d'un tuyau pour le raccordement à l'évacuation ; celui-ci devra être prévu au sol, avec une bonde siphonée.



**Attention:** s'assurer que les tuyaux d'alimentation et d'évacuation ne sont pas pliés, étranglés ou écrasés après l'installation.



## 4.1 Branchement électrique

Le branchement électrique du lave-vaisselle et des éventuels appareils supplémentaires doit être confié à un personnel autorisé et qualifié, conformément aux normes en vigueur ; respecter également les dispositions techniques de branchement.

La puissance totale installée est reportée sur la plaquette des données techniques de l'appareil.

Il est interdit de protéger d'autres appareils en même temps que le lave-vaisselle

Le revendeur devra veiller à l'installation, conformément aux normes en vigueur, d'un interrupteur général sur la ligne d'alimentation électrique et d'un disjoncteur différentiel compatible avec les caractéristiques de l'appareil.

Ces interrupteurs doivent être installés à proximité du lave-vaisselle, être facilement accessibles après l'installation et garantir la déconnexion complète du réseau électrique dans les conditions de la catégorie de surtension III. SI LE CABLE D'ALIMENTATION EST ENDOMMAGÉ IL DOIT ÊTRE REMPLACÉ PAR LE FABRICANT, SON SERVICE APRES VENTE OU DES PERSONNES DE QUALIFICATION SIMILAIRE AFIN D'ÉVITER UN DANGER



### Attention !!!

Le lave-vaisselle est hors tension uniquement lorsque l'interrupteur général est fermé.

- Brancher l'appareil au système équipotentiel. La borne  de branchement est placée en bas à l'arrière de l'appareil.
- Le conducteur de protection (PE) est de couleur jaune-verte, le conducteur neutre (N) de couleur bleue et les conducteurs de phase (L1, L2, L3) de couleur noire, grise et marron.

## 5 PREMIERE MISE EN SERVICE ( Installateur )

### PREMIERE MISE EN SERVICE

Le système électrique de protection doit être soumis à un test fonctionnel avant toute mise en service.

L'installation doit être exécutée et/ou vérifiée par le revendeur agréé qui veillera à la première mise en service et à fournir les instructions relatives au fonctionnement du lave-vaisselle.

### PREPARATION A L'UTILISATION

#### Important :

Le doseur du produit de rinçage est toujours présent, le doseur du produit de lavage n'est présent que sur certains modèles.

Si les deux doseurs sont présents, placer les bacs extérieurs du produit de lavage et du produit de rinçage puis y introduire les tuyaux respectifs de tirant situés à l'arrière de l'appareil.

Tuyau rouge : produit de lavage

Tuyau transparent : produit de rinçage

Avant d'introduire les tuyaux dans les bacs, appliquer aux extrémités le poids (nécessaire pour maintenir le tirant d'eau au fond du bac) et le filtre comme l'illustre la figure.

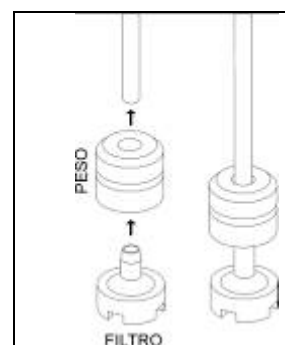
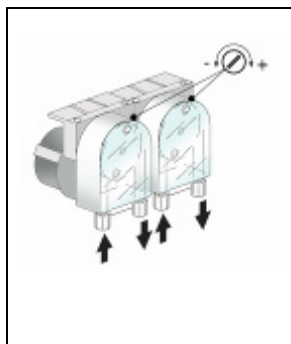

Pour le réglage, agir sur les vis de réglage indiquées dans la figure. Il est recommandé de faire exécuter cette opération par le personnel du fournisseur des produits de lavage.

Si le doseur du produit de lavage n'est pas pré-monté, il est possible de l'installer dans un second temps en commandant le KIT correspondant.

Il est également possible de raccorder un doseur extérieur en exécutant le branchement électrique à l'aide d'un câble 2x0,5 mm type H05 RN-F, inséré à travers le passage indiqué dans le schéma CARACTÉRISTIQUES TECHNIQUES et branché comme l'illustre le schéma électrique fourni avec le lave-vaisselle.

Le doseur doit être de 230V/50 Hz avec une puissance maximum absorbée de **15 W**.

Raccorder le doseur du produit de lavage extérieur au lave-vaisselle à travers le tuyau rouge cité ci-dessus.

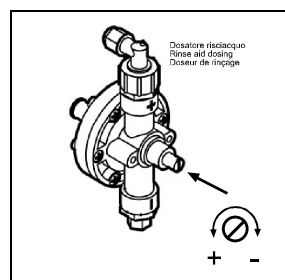

## 6 INSTRUCTIONS POUR L'UTILISATEUR

AGB 648/WP- AGB 650/DP- AGB 650/WP- AGB 654/DP- AGB 654/WP- AGB 656/WP- AGB 657/WP- AGS  
653/WP- AGB 661/DP- AGB 661/WP- AGB 663/WP

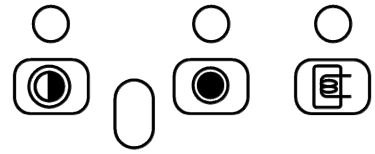
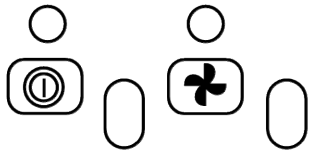

AGB 649/WP- AGB 651/DP- AGB 651/WP- AGB 655/DP- AGB 658/WP- AGS 654/WP- AGB 662/DP-  
AGB 662/WP

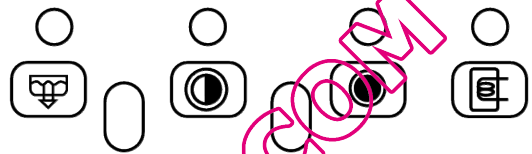
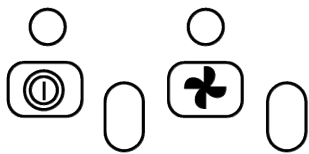

AGB 653/DP- AGB 653/WP

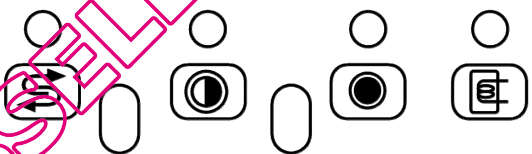
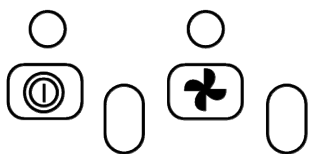

AGB 652/DP-AGB 652/WP

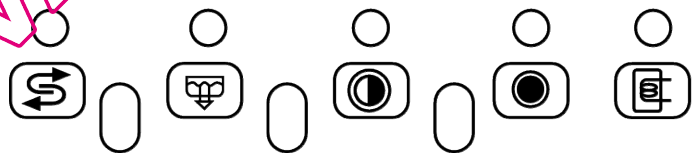
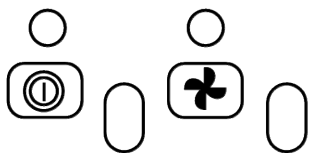



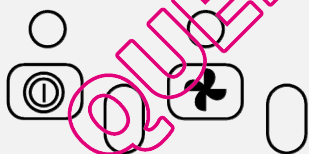



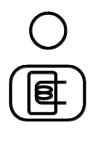
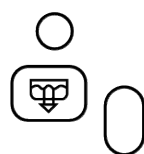
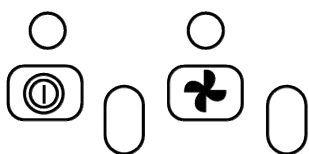

ADN408



ADN409





	Symbole bouton marche/arrêt		Témoins fonctions
	Symbole bouton cycle de lavage		Symbole bouton pompe d'évacuation
	Symbole bouton régénération		Symbole témoin boiler rinçage
	Symbole cycle court		Symbole cycle moyen

## 6.1 Avant le lavage



Utiliser exclusivement des produits de lavage et de rinçage pour lave-vaisselle industriels. Ne pas utiliser de produits vaisselle prévus pour le lavage à la main. Il est conseillé d'utiliser des produits spécialement conçus pour ce lave-vaisselle.



Pendant l'appoint des réservoirs, faire attention de ne pas échanger les produits car ceci pourrait entraîner de mauvais fonctionnements et des dommages au lave-vaisselle.

Ne pas mélanger de produits de lavage différents car ceci endommagerait le dispositif de dosage.

Les produits de lavage pour lave-vaisselle industriels peuvent causer de graves irritations. Respecter attentivement les instructions du fabricant du produit de lavage reportées sur l'emballage.

Ouvrir le robinet du réseau d'eau (réseau).	Vérifier :		Enclencher l'interrupteur général (réseau), sur l'afficheur apparaît "OFF".
	Le niveau du produit de lavage et du produit de rinçage dans les bacs.	Le positionnement correct des filtres, la rotation des arroseurs, l'absence de corps étrangers dans le lave-vaisselle.	
			

## 6.2 Chargement de la vaisselle

### ASSIETTES

Le panier peut contenir **12 assiettes creuses** ou **18 assiettes plates**.

Nettoyer les assiettes des résidus solides (os, épluchures, noyaux, etc.); laisser tremper au préalable dans l'eau froide les assiettes présentant des résidus secs de fromage, œuf, ...etc.

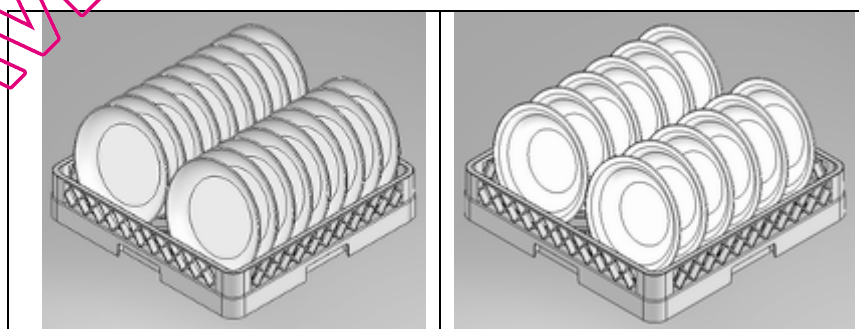

### CHARGEMENT DES VERRES











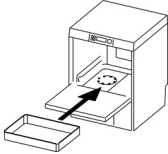
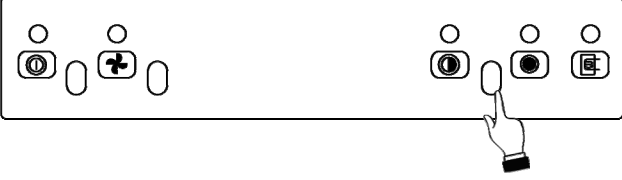

Éliminer des verres tout résidu solide éventuel (écorces, noyaux, etc.).

Placer les verres tournés vers le bas.

### COUVERTS

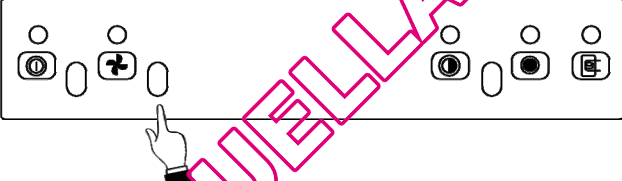
Utiliser le panier prévu à cet effet. Disposer les couverts pêle-mêle de préférence avec le manche tourné vers le bas, en faisant attention de ne pas se blesser avec les dents des fourchettes et les lames des couteaux.

### 6.3 Première utilisation journalière (cuve et boiler vides)

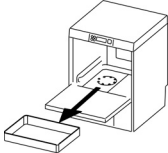
Le panneau et les symboles présentés dans cette notice pourraient se référer à des fonctions non présentes dans votre appareil.	Actions et résultats
	<p>Enclencher l'interrupteur mural, ouvrir la porte, introduire le trop-plein, fermer la porte :</p> <p>appuyer sur le bouton de <b>marche/arrêt</b> , le témoin s'allume : chargement de l'eau dans le boiler et dans la cuve. une fois que les chargements du boiler et de la cuve sont terminés, le témoin boiler  s'allume</p>
	<p>Charger le panier.</p>
	<p>Sélectionner le programme souhaité en appuyant sur :</p> <p> Cycle court ou  Cycle moyen</p>
	<p>Attendre que la lampe du boiler  soit éteinte. Pour démarrer le cycle de lavage appuyer sur </p>
	<p>Cycle en cours, le témoin du cycle s'allume. Si la porte est ouverte pendant le cycle le programme s'arrête, dès qu'elle est refermée le programme se réinitialise. Pour redémarrer, appuyer de nouveau sur le bouton du cycle </p>
	<p>Une fois que le programme est terminé, le témoin du cycle s'éteint et le témoin du boiler  s'allume.</p>
	<p>Décharger le panier.</p>

## 6.4 Cycle résines (pour modèles équipés d'un adoucisseur d'eau)

	<p>Lorsque l'appareil est à l'arrêt, ouvrir la porte et <b>enlever le trop-plein pour vider la cuve ; une fois que celle-ci est vide remettre le trop-plein</b> et refermer la porte.</p> <p>Presser la touche  : le témoin s'allume et le cycle de régénération démarre, au bout de 20 minutes le cycle de régénération se termine et l'appareil reste arrêté.</p> <p>Ouvrir la porte, vérifier si l'eau de régénération est dans la cuve, enlever le trop-plein pour vider la cuve ; une fois que celle-ci est vide remettre le trop-plein et refermer la porte. Fermer l'interrupteur général mural.</p>
--	---

Pendant l'exécution du cycle de régénération, il ne sera possible d'exécuter aucune opération. Il doit toujours être effectué lorsque la cuve est vide.

### Ajout de sel régénérant (pour modèles équipés d'un adoucisseur d'eau)





Effectuer l'ajout de sel **quand la cuve est vide** pour éviter que de l'eau de lavage n'entre dans le dispositif adoucisseur d'eau ; débrancher toujours la fiche d'alimentation de la prise de secteur avant d'exécuter cette opération. Rebrancher la fiche d'alimentation dans la prise une fois que l'opération est terminée.

**Attention : utiliser exclusivement du sel spécifique, ne pas utiliser de sel alimentaire.**

Le réservoir du sel a une capacité de **1 kg de sel en grains** environ.

Le réservoir est situé au fond de la cuve. Après avoir enlevé le panier, dévisser le bouchon et verser le sel à l'aide de l'entonnoir fourni avec l'appareil. Avant de visser de nouveau le bouchon, éliminer les éventuels résidus de sel à proximité de l'ouverture.

## 6.5 Evacuation totale en fin de journée

	<p><b>Évacuation totale en fin de journée (modèles avec pompe d'évacuation)</b></p> <p>Arrêter l'appareil en appuyant sur le bouton <b>marche/arrêt</b> , ouvrir la porte, enlever le trop-plein, appuyer sur le bouton pompe d'évacuation  jusqu'à ce que la cuve soit complètement vidée. Pour remettre l'appareil en marche il faut donc replacer le trop-plein dans la cuve, fermer la porte et presser le bouton <b>marche/arrêt</b> , ou en cas de fin de service, fermer l'interrupteur général mural.</p>
	<p><b>Évacuation totale en fin de journée (modèles sans pompe d'évacuation)</b></p> <p>Arrêter l'appareil en appuyant sur le bouton <b>marche/arrêt</b> , ouvrir la porte, enlever le trop-plein, appuyer sur le bouton pompe d'évacuation. Remettre le trop-plein et refermer la porte. Fermer l'interrupteur général mural.</p>



Ne pas arrêter le lave-vaisselle lorsque de l'eau est dans la cuve, exécuter toujours l'évacuation au préalable. En fin de service, après avoir effectué l'évacuation finale et l'éventuelle régénération, arrêter

l'appareil en appuyant sur le bouton **marche/arrêt** , fermer l'interrupteur mural et fermer le robinet de barrage de l'eau. Ne pas laisser l'appareil sous tension inactif et inutilisé pendant des périodes de temps plus ou moins longues.

## 7 ENTRETIEN ET NETTOYAGE

Même si le lave-vaisselle ne nécessite aucun entretien programmé particulier, il est conseillé de le faire contrôler deux fois par an par un technicien spécialisé.

**N.B:** Le fabricant décline toute responsabilité relative à des endommagements intentionnels ou dus à l'incurie, à la négligence, au non respect des prescriptions, des instructions et des normes ou à des raccordements incorrects.

### 7.1 Nettoyage quotidien

Le lave-vaisselle répond au degré de protection **IPX4**, mais il est **interdit** d'utiliser des jets d'eau directs pour le nettoyage.

#### NETTOYAGE DU FILTRE PENDANT LA JOURNEE

En cas d'utilisation particulièrement intense, il est conseillé d'effectuer le nettoyage du filtre tous les 30-40 cycles pour maintenir le bon fonctionnement de l'appareil. Pour cette opération, exécuter l'"évacuation partielle de la cuve".

Enlever les filtres (il suffit de les soulever de leur logement comme l'illustre la figure), en évitant de faire tomber des résidus grossiers dans le puits sous les filtres, nettoyer ces derniers des résidus et les rincer abondamment. Les replacer correctement. Pour cette opération ne pas utiliser d'objets pointus ou coupants.

Nettoyer les éventuelles incrustations de calcaire pour éviter toute accumulation ;

- Nettoyer soigneusement et fréquemment les surfaces à l'aide d'un chiffon humide. Utiliser des produits de nettoyage neutres, non abrasifs, dépourvus de substances à base de chlore, corrosives ou endommageant l'acier inox.

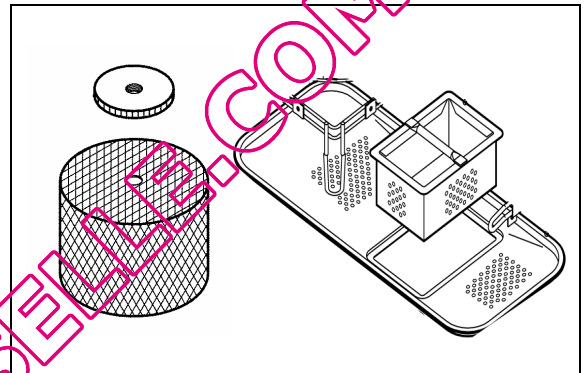

Ne pas utiliser non plus les produits reportés ci-dessus pour nettoyer le sol sous le lave-vaisselle ou à proximité de celui-ci pour éviter que des vapeurs ou des gouttes ne puissent endommager les surfaces en acier.

### 7.2 Contrôles périodiques

Démonter les arroseurs (inférieur et supérieur 2,4) en dévissant la vis centrale (4) ; dévisser les bouchons aux deux extrémités des arroseurs de lavage (7).

Nettoyer les trous et les gicleurs sous un jet d'eau courante propre, pour cette opération ne pas utiliser d'outils susceptibles de causer des dommages. Remonter soigneusement les arroseurs.

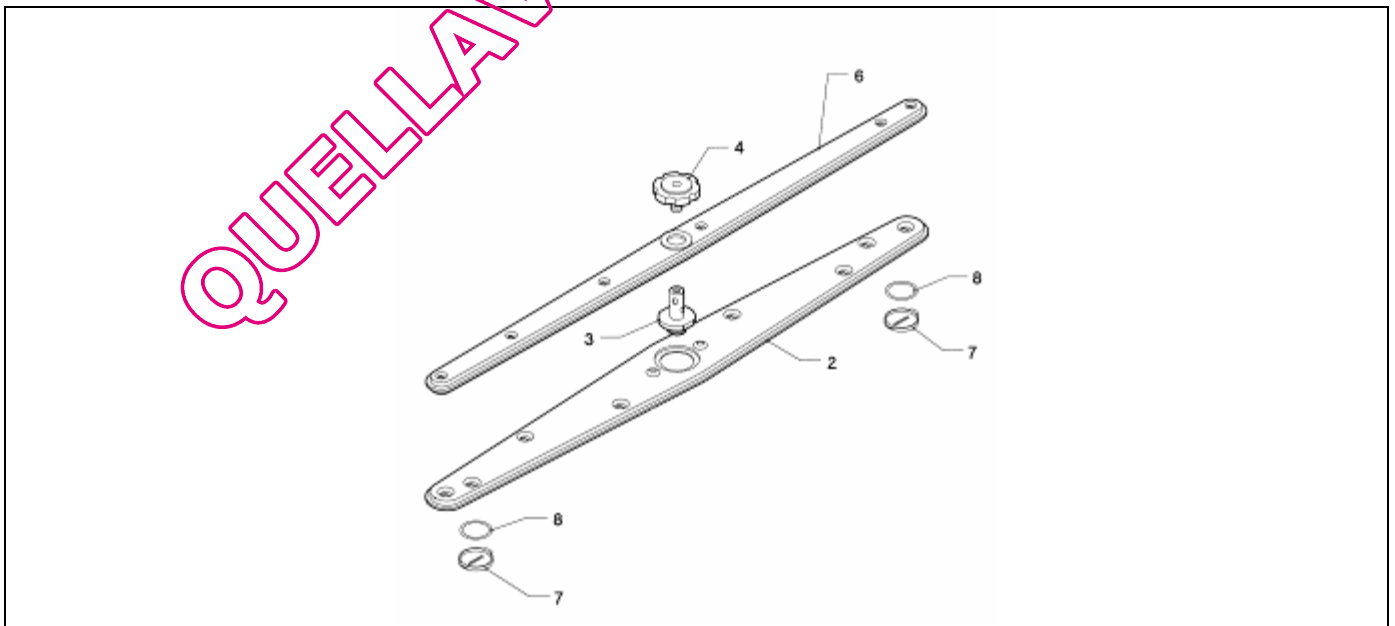

Nettoyer l'extérieur de l'appareil à l'aide d'un chiffon humide et de savon neutre puis rincer soigneusement et sécher.

### 7.3 Non utilisation prolongée

S'il est prévu de ne pas utiliser le lave-vaisselle pendant une période de temps plutôt longue, **il faut effectuer la vidange du dispositif de distribution du produit de lavage et du produit de rinçage pour éviter toute cristallisation et tout dommage aux pompes** : enlever les tuyaux de tirant des bacs des produits de lavage et de rinçage puis les plonger dans un récipient contenant de l'eau propre, exécuter quelques cycles de lavage, effectuer l'évacuation complète.

Enfin, fermer l'interrupteur général, fermer le robinet d'amenée d'eau. Les tuyaux de tirant des produits de lavage et de rinçage devront être réinsérés dans les bacs au moment de la mise en service, **en prenant soin de ne pas les inverser (tuyau rouge = produit de lavage ; tuyau transparent = produit de rinçage)**.

**Ne pas laisser l'appareil sous tension inactif et inutilisé pendant des périodes de temps plus ou moins longues.**



## 8 PROBLÈMES ET ANOMALIES (UTILISATEUR)



PROBLEME	CAUSE POSSIBLE	SOLUTION POSSIBLE
LE TMOIN DE LIGNE NE S'ALLUME PAS	Absence de tension de réseau	Vérifier le branchement au réseau électrique.
LE PROGRAMME DE LAVAGE NE DEMARRE PAS	Le remplissage du lave-vaisselle n'est pas encore terminé.	Attendre que le témoin du boiler s'allume.
MAUVAIS RESULTATS DE LAVAGE	Trous de lavage des arroseurs bouchés ou incrustés	Démonter et nettoyer les arroseurs (10.2 Contrôles périodiques)
	Produit de lavage ou produit de rinçage insuffisant ou non approprié	Vérifier le type et la quantité du produit de lavage.
	Assiettes/verres mal rangés	Disposer les assiettes/verres de manière adéquate.
	Basse température de lavage	Vérifier la température affichée, si elle est inférieure à 50° contacter le service après-vente.
	Cycle sélectionné inadéquat	Augmenter la durée du cycle de lavage, notamment si la vaisselle est très sale ou sèche.
RINÇAGE INSUFFISANT	Gicleurs des arroseurs bouchés Boiler incrusté de calcaire	Vérifier la propreté des gicleurs et si l'adoucisseur éventuellement monté fonctionne correctement.
VERRES ET COUVERTS TACHES	Produit de rinçage inadéquat et mal distribué. Dureté de l'eau supérieure à 12°dF ou beaucoup de sels dissous	Vérifier si le bac du produit de rinçage correspond au type d'eau du réseau. Si le problème persiste, contacter le service après-vente.
PRESENCE D'EAU DANS LA CUVE APRES L'ÉVACUATION	Tuyau d'évacuation mal positionné ou partiellement bouché	Vérifier si le tuyau et l'évacuation du lave-vaisselle ne sont pas obstrués et si le tuyau d'évacuation n'est pas positionné trop haut ; voir schéma de raccordement.

- 1 Sicherheits- und Gebrauchshinweise**
- 2 Technische Merkmale**
- 3 Installation und Aufstellung**
- 4 Anleitung für den Installateur**
- 5 Inbetriebnahme**
- 6 Gebrauchsanleitung für mechanische Modelle**
- 7 Wartung und Reinigung (Benutzer)**
- 8 Störungen und Fehler (Benutzer)**

Wir bedanken uns für die Wahl dieses Geräts.  
Das vorliegende Handbuch mit allen für einen korrekten Gebrauch der Geschirrspülmaschine nötigen Informationen bitte aufmerksam lesen.

#### **TECHNISCHE ANLEITUNGEN:**



Diese Informationen richten sich an das Fachpersonal für Installation, Inbetriebnahme, technische Prüfung und etwaige Kundendienstmaßnahmen.

#### **GEBRAUCHSANLEITUNGEN:**

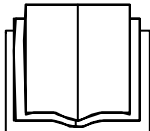

Wichtige Hinweise für den Gebrauch, Befehlsbeschreibung und korrekte Reinigungs- und Wartungsmaßnahmen der Geschirrspülmaschine.



# 1 SICHERHEITS- UND GEBRAUCHSHINWEISE



**DIESES HANDBUCH IST FESTER BESTANDTEIL DER GESCHIRRSPÜLMASCHINE; STETS VOLLSTÄNDIG GEMEINSAM MIT DEM GERÄT AUFBEWAHREN.**



**AUFSTELLUNG, ANSCHLÜSSE, INBETRIEBNAHME UND FEHLERBEHEBUNG SOWIE DAS AUSWECHSELN DES STROMVERSORGUNGSKABELS DÜRFEN AUSSCHLIESSLICH VON QUALIFIZIERTEM FACHPERSONAL VORGENOMMEN WERDEN.**

DER GESCHIRRSPÜLER IST AUSSCHLIESSLICH FÜR DEN PROFESSIONELLEN GEBRAUCH DURCH BEFUGTES PERSONAL BESTIMMT. DAS GERÄT IST FÜR DAS SPÜLEN VON GESCHIRR (TELLER, TASSEN, SCHÜSSELN, BLECHE, BESTECK) UND ÄHNLICHEM IN DER GASTRONOMIE UND DER GEMEINSCHAFTSVERPFLEGEUNG BESTIMMT UND ENTSPRICHT DEN INTERNATIONALEN NORMEN FÜR ELEKTRISCHE UND MECHANISCHE SICHERHEIT (CEI-EN-IEC 60335-2-58/61770) UND FÜR ELEKTROMAGNETISCHE KOMPATIBILITÄT (CEI-IEC-EN 55014-1/-2, 61000-3;4, 50366).

DER HERSTELLER ÜBERNIMMT KEINERLEI HAFTUNG FÜR PERSONEN- ODER SACHSCHÄDEN, DIE DURCH **NICHTBEACHTUNG** DER HINWEISE IN DIESEM HANDBUCH, DURCH **UNSACHGEMÄSSEN GEBRAUCH**, DURCH **UNBEFUGTE EINGRIFFE** AM GERÄT ODER AUCH NUR AN EINEM EINZIGEN GERÄTETEIL UND DURCH DIE VERWENDUNG **NICHT ORIGINALER ERSATZTEILE** VERURSACHT WERDEN.



**DAS GERÄT MUSS GEMÄSS DER SICHERHEITSVORSCHRIFTEN FÜR ELEKTROANLAGEN KORREKT GEERDET WERDEN.**

DIESES GERÄT TRÄGT DAS KONFORMITÄTSZEICHEN DER EUROPÄISCHEN RICHTLINIE **2002/96/EC**, WASTE ELECTRICAL AND ELECTRONIC EQUIPMENT (WEEE).

ES IST AUFGABE DES BENÜTZERS, FÜR EINE KORREKTE ENTSORGUNG DES GERÄTS ZU SORGEN, UM ETWAIGEN NEGATIVEN, UMWELT- UND GESUNDHEITSSCHÄDLICHEN AUSWIRKUNGEN VORZUBEUGEN.

DAS AUF DEM GERÄT SELBST ODER AUF DEN BEILIEGENDEN UNTERLAGEN ANGEBRACHTES SYMBOL  DRÜCKT AUS, DASS DIESES GERÄT NICHT ZUM NORMALEN HAUSMÜLL GEHÖRT, SONDERN IN EINEM SPEZIELLEN RECYCLINGHOF FÜR ELEKTRO- UND ELEKTRONISCHE GERÄTE ENTSORGT WERDEN MUSS.

DASS GERÄT MUSS GEMÄSS DER GELTENDEN ÖRTLICHEN BESTIMMUNGEN ZUR MÜLLENTSORGUNG ZERLEGT WERDEN.

WENDEN SIE SICH FÜR NÄHERE INFORMATIONEN BEZÜGLICH DER BEHANDLUNG, ENTSORGUNG UND WIEDERVERWERTUNG DIESES GERÄTS AN DAS ZUSTÄNDIGE ÖRTLICHE AMT, DEN MÜLLABFUHRVERBAND ODER IHREN HÄNDLER.



**NIEMALS LÖSUNGSMITTEL WIE ALKOHOL ODER TERPENTIN EINFÜHREN. DERARTIGE STOFFE KÖNNEN EXPLOSIONEN VERURSACHEN. NIEMALS GESCHIRR MIT ASCHEN-, WACHS- ODER LACKRESTEN EINFÜHREN.**



**DEN GESCHIRRSPÜLER ODER TEILE DAVON NIEMALS ALS STUFE, STÜTZE ODER HALTERUNG FÜR PERSONEN, DINGE ODER TIERE VERWENDEN.**

**NICHT AUF DIE GEÖFFNETE TÜRKAPPE DER GESCHIRRSPÜLMASCHINE SETZEN ODER SICH ANLEHNEN. ES DROHT KIPPGEFAHR MIT ENTSPRECHENDER VERLETZUNGSGEFAHR FÜR PERSONEN. DIE TÜRKAPPE DER GESCHIRRSPÜLMASCHINE WEGEN STOLPERGEFAHR NIEMALS OFFEN LASSEN.**



**ETWAIGE, NACH EINEM SPÜLGANG VORHANDENDE WASSERRÜCKSTÄNDE IM GESCHIRR ODER IM GESCHIRRSPÜLER NIEMALS TRINKEN.**



**DAS GERÄT IST NICHT FÜR DEN GEBRAUCH DURCH MINDERJÄHRIGE ODER PERSONEN MIT VERMINDERTEN KÖRPERLICHEN, WARNEHMUNGS- ODER GEISTIGEN FÄHIGKEITEN BZW. DURCH UNERFAHRENES PERSONAL GEEIGNET. DERARTIGE PERSONEN DÜRFEN DAS GERÄT NUR UNTER AUFSICHT EINER FÜR IHRE SICHERHEIT VERANTWORTLICHEN PERSON GEBRAUCHEN.**



## 2 TECHNISCHE MERKMALE

		ADN408- ADN409	AGB648-AGB649- AGB650-AGB651- AGB652-AGB653- AGB654-AGB655- AGB656	AGB657-AGB658- AGB661-AGB662- AGB663-AGB653- AGB654
Stromversorgung	V	400V/3+N 230V/1	400V/3+N 230V/1	400V/3+N 230V/1
Frequenz	Hz	50	50	50
Max. Leistungsaufnahme	kW	4,9	4,9	5,1 – 6,6
Leistung des Boiler-Heizkörpers	kW	4,5	4,5	4,5 - 6
Leistung des Tank-Heizkörpers	kW	2,5	2,5	2
Leistung der Pumpe	kW	0,4	0,4	0,6
Wasserdruck	kPa	200-400	200-400	200-400
Wassertemperatur	°C	50 – 60	50 – 60	50 – 60
Wassertemperatur Ausführungen "A" (eingebauter Wasserenthärter)	°C	15 – 30	15 – 30	15 – 30
Wasserhärte	°dF	7 – 12	7 – 12	7 – 12
Wasserverbrauch pro Nachspülgang	l	2,4	2,4	2,4
Boilerkapazität	l	7	7	7
Tankkapazität	l	26	26	14,5
Dauer Standardzyklus mit Wasserversorgung bei 50°C	s	120	120/180	120/180
Geräuschpegel	dB(A)	66	66	66
Schutzgrad	IPX	4	4	4
Nettogewicht	kg	64	64	66
Stromversorgungskabel Typ	◀HAR▶	H05VV-F	H05VV-F	H05VV-F

QUELLAVENDEUTSCH.COM

### 3 INSTALLATION UND AUFSTELLUNG

#### INSTALLATION UND AUFSTELLUNG

Den Geschirrspüler an seinen Installationsort bringen, Verpackung entfernen und das Gerät und seine Bestandteile auf Unversehrtheit überprüfen. Etwaige Schäden müssen dem Lieferanten schriftlich mitgeteilt werden.

Die Verpackungsbestandteile (Plastiktüte, Styroporschäum, Nägel, etc.) stellen potentielle Gefahrenquellen dar und müssen deshalb für Kinder und Haustiere unzugänglich sein.

Es werden ausschließlich umweltverträgliche Verpackungsmaterialien verwendet. Sie können bedenkenlos aufbewahrt oder in einer speziellen Abfall-Entsorgungszentrale entsorgt werden.

Für eine etwaige Entsorgung mit Recycling sind die verschiedenen Kunststoffmaterialien folgendermaßen gekennzeichnet:

PE Polyethylen: Umverpackungsfolie, Kunststoffhülle für die Gebrauchsanleitung, Schutzhüllen.

PP Polypropylen: Verpackungsbänder.

PS Styropor-Schaumstoff: Schutzdecken, Verpackungsdeckel.

Holzbestandteile und Kartons müssen gemäß der geltenden Vorschriften entsorgt werden. Altgeräte niemals in der Umwelt abladen. Die Demontage muss gemäß der geltenden Vorschriften erfolgen. Alle Metallbestandteile können ausgebaut werden und sind aus rostfreiem Edelstahl. Alle Kunststoffbestandteile sind mit dem Symbol des entsprechenden Materials gekennzeichnet.

#### AUFSTELLUNG:



**Achtung:** Die Innenanlage und die Räume, in denen die Geräte für Gemeinschaftsverpflegung installiert werden, müssen den geltenden Vorschriften entsprechen.

Der Hersteller übernimmt für etwaige Schäden, die durch die Nichtbeachtung dieser Vorschriften verursacht werden, keinerlei Haftung.

Vor der Installation sicherstellen, dass sich in der Nähe des Aufstellorts keine bzw. nur entsprechend geschützte Gegenstände oder Materialien befinden, die durch den Wasserdampf oder durch Spritzer der Waschflüssigkeit beschädigt werden könnten.

Geschirrspüler am gewünschten Ort aufstellen und Schutzfolie entfernen.

Geschirrspüler (mit einer Wasserwaage) auf den vier Stützfüßen fest und stabil aufstellen. Weitere Aufstellungslösungen müssen zuerst vom Hersteller genehmigt werden.

### 4 ANLEITUNG FÜR DEN INSTALLATEUR

#### HYDRAULIKANSCHLUSS UND ABFLUSS:

Die Hydraulikleitungen und das Versorgungskabel treten an der Maschinenrückseite aus dem Geschirrspüler aus. Die Wasserversorgungsleitung an einen Anschluss mit einer  $\frac{3}{4}$ " Gewindeöffnung anschließen.

Für den Anschluss an die Wasserversorgung ausschließlich neue Leitungen verwenden. Der Gebrauch alter oder gebrauchter Leitungen ist untersagt.

Der dynamische **Versorgungsdruck** muss zwischen **2 und 4 bar** betragen, bei Überschreitung dieses Werts muss ein Druckminderer installiert werden.

An der Wassereinflaufleitung muss ein Hauptventil installiert werden; Dieses Ventil muss auch nach vollendeter Installation zugänglich sein und darf deshalb nicht an der Rückseite des Geschirrspülers angebracht werden.

Die Angaben hinsichtlich der Zyklusdauer beziehen sich auf eine **Warmwasserversorgung bei 50°C**.

Bei Kaltwasserversorgung können die Spülgänge je nach Wassertemperatur auch länger dauern, da die Maschine mit Nachspülgang bei konstanter Temperatur und gleichbleibendem Druck arbeitet.

#### ABFLUSS:

Jede Geschirrspülmaschine ist mit einem Abfluss-Verbindungsrohr ausgestattet. Der Abfluss muss im Boden mit Siebplatte erfolgen.



**Achtung:** Sicherstellen, dass die Versorgungs- und Abflussleitungen nach der Installation nicht gebogen, abgeklemmt oder zusammengedrückt werden.



## 4.1 Stromanschluss

Der Stromanschluss der Geschirrspülmaschine und etwaiger Zusatzgeräte muss gemäß der geltenden Vorschriften erfolgen und darf ausschließlich von befugtem Fachpersonal vorgenommen werden; technische Hinweise für den Anschluss beachten.

Die Gesamtleistung ist auf der technischen Datenplakette des Geräts angegeben.

An den Schutzkreis des Geschirrspülers dürfen keine weiteren Geräte angeschlossen werden.

Der Benutzer muss gemäß der geltenden Vorschriften bei der Installation für die Anbringung eines Hauptschalters an der Stromversorgungsleitung und für einen mit den Merkmalen der Maschine kompatiblen Differential-Schalter sorgen.

Beide Schalter müssen in der Nähe der Maschine angebracht werden, auch nach der Installation leicht zugänglich sein und die vollständige Trennung vom Stromnetz bei Überspannung Kategorie III gewährleisten.



### Achtung!!!

Die Stromzufuhr des Geschirrspülers ist nur bei abgeschaltetem Hauptschalter sicher unterbrochen.

- Maschine ans normale Verbraucher-Gleichstromnetz anschließen. Die Kabelklemme ⚡ für den Anschluss befindet sich im unteren, hinteren Bereich der Maschine.
- Der Schutzleiter (PE) ist gelb-grün, der Neutralleiter (N) blau und die Phasenleiter (L1, L2, L3) sind schwarz, grau und braun.

## 5 INBETRIEBNAHME ( Installateur )

### INBETRIEBNAHME

Die Stromschutzanlage muss vor der Inbetriebnahme einem Funktionstest unterzogen werden.

Die Installation muss vom Vertragshändler vorgenommen und/oder überprüft werden, ebenso nimmt dieser die Inbetriebnahme der Maschine und deren Betriebseinführung vor.

### PREPARAZIONE ALL'USO

#### Wichtig:

Jedes Gerät verfügt über einen Klarspülerdosierer, über einen Spülmitteldosierer nur einige Modelle.

**Ist die Maschine mit beiden Dosiervorrichtungen versehen,** Klarspüler- und Spülmittelbehälter einsetzen und die Entnahmeleitungen an der Maschinenrückseite einfügen.

Rote Leitung: Spülmittel

Transparente Leitung: Klarspüler

Zuvor die Gewichte an den Leitungsenden anbringen (um die Entnahmevorrichtung am Behälterboden zu halten) und den Filter wie in der Abbildung einsetzen.

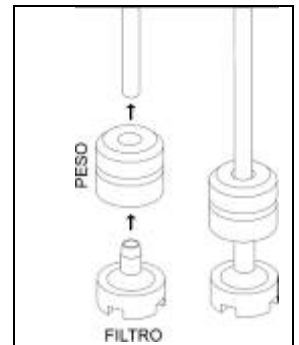
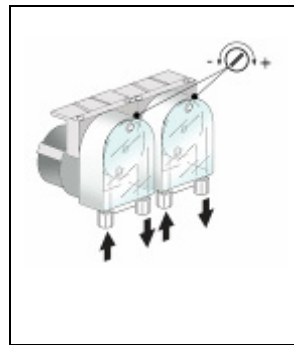

Zur Regelung die Einstellschraube wie in der Abbildung drehen. Die Einstellung sollte vom Fachpersonal des Reinigungsmittellieferanten vorgenommen werden.

Für Ausführungen ohne Spülmitteldosierer kann das Dosierset nachbestellt und nachträglich installiert werden.

Alternativ kann auch ein externer Dosierer mit einem elektrischen 2x0,5 mm Verbindungskabel Typ H05 RN-F angeschlossen werden. Für die Verlegung und den Anschluss siehe das beigefügte Schema TECHNISCHE MERKMALE und den Schaltplan.

Verwenden Sie einen Dosierer zu 230V/50 Hz mit maximaler Leistungsaufnahme von **15 W**.

Dann den externen Spülmitteldosierer mit der oben genannten roten Leitung an die Spülmaschine anschließen.

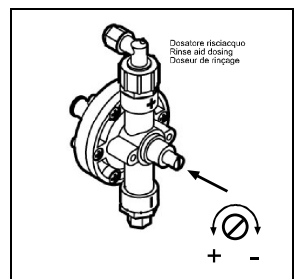

## 6 GEBRAUCHSANLEITUNG FÜR MECHANISCHE MODELLE

AGB 648/WP- AGB 650/DP- AGB 650/WP- AGB 654/DP- AGB 654/WP- AGB 656/WP- AGB 657/WP- AGS 653/WP- AGB 661/DP- AGB 661/WP- AGB 663/WP

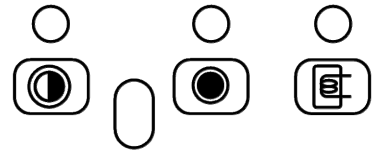
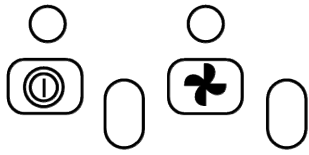

AGB 649/WP- AGB 651/DP- AGB 651/WP- AGB 655/DP- AGB 658/WP- AGS 654/WP- AGB 662/DP- AGB 662/WP

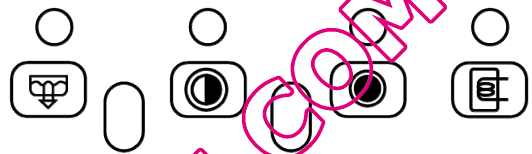
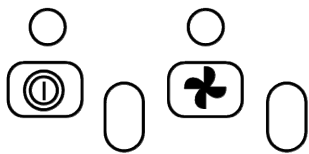

AGB 653/DP- AGB 653/WP

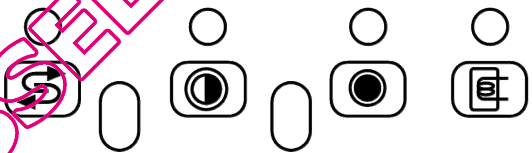
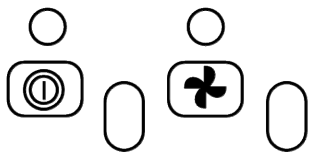

AGB 652/DP- AGB 652/WP

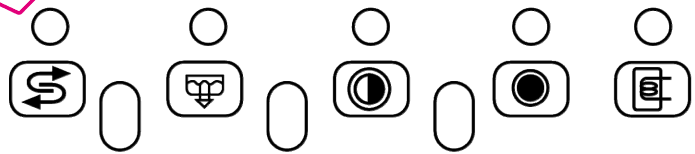
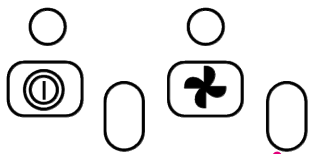



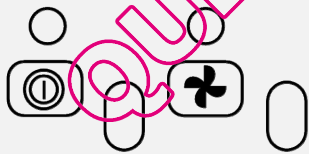



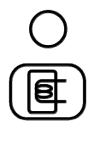
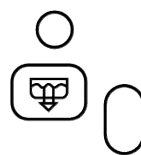
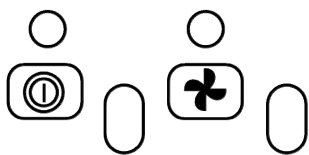

ADN408



ADN409



	Symbol On/Off-Schalter		Kontrolllampchen Funktionen
	Symbol Schalter Spülzyklus		Symbol Schalter Abfluspumpe
	Symbol Schalter Wiederherstellung		Symbol Kontrolllampchen Boiler Nachspülgang
	Schalter Kurzzyklus		Mittlerer Kurzzyklus

## 6.1 Vor dem Spülen

Ausschließlich Geschirrspülmittel und Klarspüler für Industrie-Geschirrspüler verwenden. Keine Handspülmittel verwenden.



Wir empfehlen den Gebrauch eigens für diesen Geschirrspüler entwickelter Mittel.



Während des Befüllens der beiden Behälter Spülmittel und Klarspüler nicht vertauschen, um Betriebsbeeinträchtigungen und Maschinenschäden vorzubeugen.

Verschiedene Spülmittel niemals mischen, um Schäden am Dosierer vorzubeugen.

Spülmittel für Industriegeschirrspüler können schwere Reizungen verursachen. Stets die Herstellerhinweise auf der Verpackung des Spülmittels genau befolgen.

Wasser- versorgungshahn öffnen (Benutzer).	Überprüfen:		Hauptschalter betätigen (Benutzer), auf dem Display erscheint "OFF".
	Füllstand von Spülmittel und Klarspüler in den Behältern.	Korrekte Anbringung der Filter, die Rotation der Spritzleisten, keine Fremdkörper im Geschirrspüler.	
			

### TELLER

Der Korb fasst

**12 tiefe** Teller bzw. **18 flache** Teller.

Feste Speiserückstände entfernen (wie Knochen, Schalen, Kerne, etc.); Teller mit trockenen Speiseresten wie Käse, Ei, etc. zuvor in kaltem Wasser einweichen lassen.

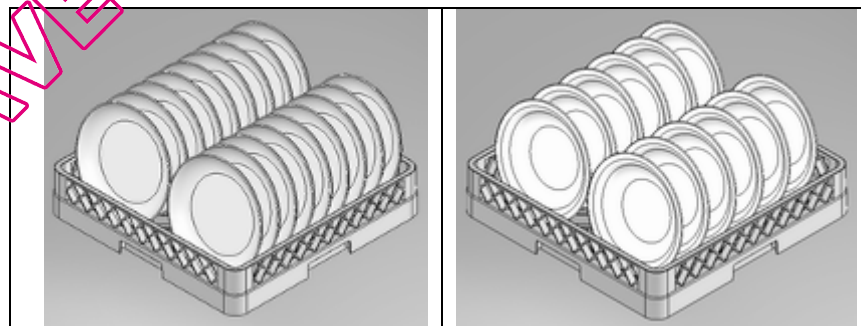

### GLÄSER EINRÄUMEN:

Von den Gläsern etwaige feste Speisereste (Schalen, Kerne, etc.) entfernen.











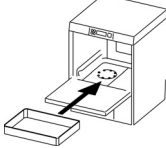

Gläser mit Rand nach unten einräumen.

### BESTECK:

Besteckkorb verwenden. Besteck lose einlegen, möglichst mit dem Griff nach unten. Dabei auf etwaige Verletzungsgefahren durch Gabelspitzen oder Messerschneiden achten.

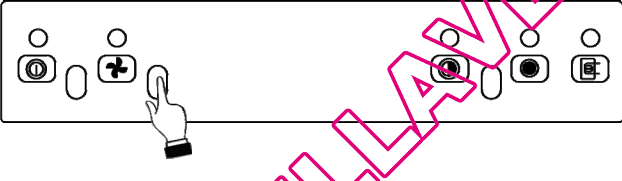
## 6.2 TÄGLICHER ERSTBETRIEB (bei leerem Tank und Boiler)

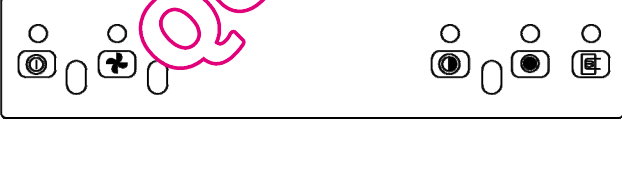
Nicht alle Funktionen der im vorliegenden Handbuch abgebildeten Bedientafel und Graphik	Maßnahme und Wirkung
---	----------------------

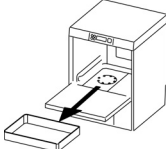
sind notwendigerweise bei Ihrer Maschine vorgesehen.	
	<p>Wandschalter drücken, Tür öffnen, Überlauf einfügen, Tür wieder schließen:</p> <p><b>On/Off</b> Schalter  drücken, das Kontrolllämpchen leuchtet auf, es beginnt der Wassereinlauf in Boiler und Tank.</p> <p>Nach beendetem Füllvorgang leuchtet das Boiler Kontrolllämpchen  auf</p>
	<p>Korb einräumen</p>
	<p>Gewünschte Programmtaste drücken:</p> <p> Kurzgang oder</p> <p> Mittlererang</p>
	<p>Warten, bis das Boiler Kontrolllämpchen  erlischt. Zum Start des Spülgangs</p> <p>Zyklustaste  drücken</p>
	<p>Beim Zyklusstart leuchtet das Zyklus Kontrolllämpchen auf. Wird die Tür während des Spülgangs geöffnet, so wird das Programm unterbrochen und nach Schließen der Tür null gestellt. Zyklustaste  drücken, um das Programm erneut zu starten.</p>
	<p>Nach Beendigung des Spülgangs erlischt das Zykluslämpchen und das Boiler Kontrolllämpchen  leuchtet auf.</p>
	<p>Korb ausräumen</p>



### 6.3 HARZFILTER-SPÜLGANG (nur für Modelle mit Wasserenthärter)

	<p>Tür der abgeschalteten Maschine öffnen und <b>Überlauf herausnehmen, um den Tank zu entleeren; anschließend den Überlauf wieder einsetzen</b> und Tür schließen. Taste  drücken: Das Kontrollämpchen leuchtet auf und der Wiederherstellungszyklus wird gestartet. Nach 20 Minuten ist der Spülgang beendet und die Maschine bleibt ausgeschaltet. Tür öffnen und sicherstellen, dass das Wasser dieses Spülgangs im Tank ist, dann den Überlauf herausnehmen und Tank entleeren; Nach der Entleerung den Überlauf wieder einsetzen und Tür wieder schließen. Hauptschalter ausschalten.</p>
--	---

Während des Wiederherstellungszyklus können keine weiteren Vorgänge ausgeführt werden. Diesen Zyklus nur bei leerem Tank starten.

#### Salz einfüllen (für Modelle mit Wasserenthärter)

Salz nur **bei leerem Tank** nachfüllen, damit kein Spülwasser in den Wasserenthärter gelangt; Der Stromstecker muss bei diesem Vorgang stets gezogen sein. Denken Sie daran, den Stromstecker anschließend wieder einzustecken.

#### Achtung: Nur Spezsalsalz, kein Speisesalz verwenden.

Der Salzbehälter hat eine Kapazität von ca. **1 kg Salzkörnern**.

Der Salzbehälter sitzt im Tankboden. Zuerst Korb herausnehmen, Deckel abdrehen und mit Hilfe des beiliegenden Trichters Salz einfüllen. Etwaige Salzrückstände um den Behälter entfernen und Deckel wieder zuschrauben.

### 6.4 Gesamtabfluss zu Betriebsende

	<p><b>Gesamtabfluss zu Betriebsende (Modelle mit Abfluspumpe)</b></p> <p>Maschine mit der <b>On/Off-Taste</b>  ausschalten, Tür öffnen und Überfluss herausnehmen und den Abfluspumpenschalter  gedrückt halten, bis der Tank vollständig entleert wurde. Um die Maschine wieder einsatzbereit zu machen, Überlauf wieder in den Tank einsetzen und <b>die On/Off-Taste</b>  drücken oder bei Betriebsende direkt den Hauptschalter betätigen.</p> <p><b>Gesamtabfluss zu Betriebsende (Modelle ohne Abfluspumpe)</b></p> <p>Maschine mit der <b>On/Off-Taste</b>  ausschalten, Tür öffnen und Überfluss herausnehmen, bis der Tank vollständig entleert wurde. Überlauf wieder in den Tank einsetzen und Tür schließen. Hauptschalter ausschalten.</p>
--	---



Geschirrspüler niemals mit Wasserrückständen im Tank abschalten, stets den Abfluss betätigen. Bei Betriebsende nach vorgenommenem Abfluss und etwaigem Wiederherstellungszyklus die Maschine mit

der Taste ausschalten, Hauptschalter ausschalten und Wasserabsperrhahn zu drehen. Die Maschine niemals über einen mehr oder weniger langen Zeitraum unbetrieben eingeschaltet lassen.



## 7 WARTUNG UND REINIGUNG

Obwohl kein spezielles Wartungsprogramm vorgeschrieben ist, sollte die Maschine zweimal pro Jahr von einem Fachmann überprüft werden.

**ACHTUNG:** Für beabsichtigt hervorgerufene Beschädigungen oder durch Unachtsamkeit, Nichtbeachtung der Gebrauchshinweise und –Vorschriften oder durch fehlerhafte Anschlüsse hervorgerufene Schäden trägt der Hersteller keinerlei Verantwortung.

### 7.1 Tägliche Reinigung

Der Geschirrspüler entspricht Schutzgrad **IPX4**, der Gebrauch direkter Wasserstrahlen ist dennoch **untersagt**.

#### **FILTERREINIGUNG WÄHREND DES TÄGLICHEN BETRIEBS**

Bei besonders intensivem Spülbetrieb sollte der Filter etwa nach allen 30-40 Spülgängen gereinigt werden, um die Maschine stets in betriebsfähigem Zustand zu halten. Dazu die "partielle Tankentleerung" vornehmen.

Filter herausnehmen (durch einfaches Anheben, siehe Abbildung), dabei aufpassen, dass keine groben Rückstände in die Öffnung unter dem Filter fallen. Dann Rückstände von den Filtern entfernen und gründlich abspülen, anschließend wieder korrekt einsetzen.

Keine spitzen oder scharfen Gegenstände verwenden.

Etwaige Kalkablagerungen entfernen;

- Die Oberflächen häufig und gründlich mit einem feuchten Lappen reinigen; Neutralreiniger verwenden, keine Scheuermittel, keine chlorhaltigen Mittel und keine korrosiven, für Edelstahl schädliche Mittel verwenden.

Die oben genannten Mittel auch nicht zur Reinigung des Bodens unterhalb der Maschine oder des Maschinenumfelds verwenden, um durch Dämpfe oder Spritzer hervorgerufene Schäden an den Edelstahlfächen zu vermeiden.

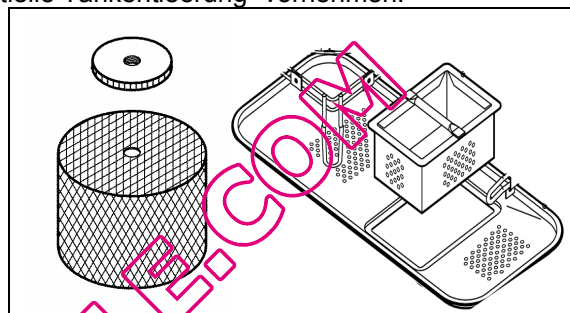

### 7.2 Regelmäßige Wartung

Zentrale Schraube (4) entfernen und die (unteren und oberen 2-4) Spritzleisten abmontieren. Die Verschlusskappen an den Enden der Spritzleisten (7) abnehmen.

Bohrungen und Düsen mit einem sauberen Wasserstrahl reinigen, kein Werkzeug verwenden, das eventuell Schäden verursachen könnte. Spritzleisten sorgfältig wieder anbringen.

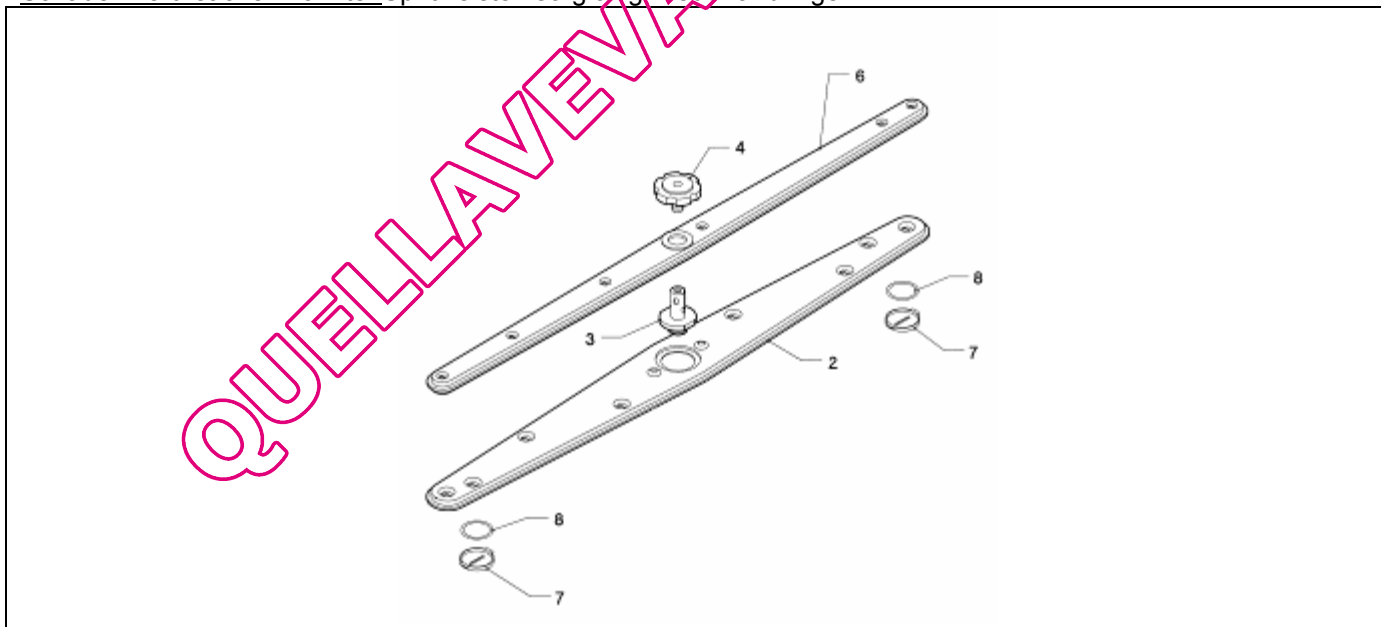

Außenfläche der Maschine mit einem feuchten Tuch und Neutralreiniger abwischen und gut trocknen.

### 7.3 Längerer Maschinenstillstand

Sollte der Geschirrspüler für längere Zeit nicht benutzt werden, **so müssen die Spülmittel- und Klarspülerdosierer geleert werden, um der Kristallisierung und etwaigen Schäden an der Pumpe vorzubeugen**: Dosierleitungen der Spülmittel- und Klarspülerdosierer abnehmen und in ein Gefäß mit sauberem Wasser geben, einige Spülgänge und schließlich einen kompletten Abfluss ausführen.

Zum Schluss Hauptschalter ausschalten, Wasserversorgungshahn schließen. Die Dosierleitungen der Spülmittel- und Klarspülerdosierer bei der erneuten Inbetriebnahme wieder einsetzen, dabei **darauf achten, sie nicht zu vertauschen (rote Leitung = Spülmittel; transparente Leitung = Klarspüler)**.

**Die Maschine bei (längerem oder kürzerem) Stillstand niemals eingeschaltet lassen.**



## 8 FEHLER UND STÖRUNGEN (BENUTZER)



PROBLEM	MÖGLICHE URSACHE	MÖGLICHE BEHEBUNG
DAS KONTROLLLÄMPCHEN LEUCHTET NICHT	Keine Stromspannung	Stromanschluss überprüfen.
SPÜLPROGRAMM STARTET NICHT	Maschineneinlauf nicht beendet.	Warten, bis das Boiler-Kontrollämpchen aufleuchtet.
UNBEFRIEDIGENDE SPÜLERGEBNISSE	Spülöffnungen verstopft oder verkrustet	Spritzleisten abnehmen und reinigen (10.2 regelmäßige Wartung)
	Zu wenig oder nicht geeignetes Spülmittel bzw. Klarspüler	Spülmittelmenge und -Typ überprüfen.
	Teller / Gläser ungünstig eingeräumt	Teller / Gläser gut einräumen.
	Niedrige Spültemperatur	Temperaturanzeige auf dem Display überprüfen, liegt sie unter 50° den Kundendienst rufen.
	Spülgang nicht geeignet eingestellt	Spülgangdauer steigern, vor allem bei besonders hartnäckigem, eingetrocknetem Schmutz.
UNBEFRIEDIGENDE NACHSPÜLERGEBNISSE	Spritzleistendüsen verstopft Boiler verkalkt	Reinigung der Düsen und korrekten Betrieb des Wasserenthärter (falls vorhanden) überprüfen.
GLÄSER UND BESTECK SIND FLECKIG	Klarspüler ungeeignet bzw. wird nicht richtig dosiert. Wasserhärte beträgt mehr als 12°dF oder zu große Menge gelöster Salze	Klarspülerbehälter überprüfen, Klarspüler muss für die Art des Leitungswassers geeignet sein. Bei fortbestehender Störung Kundendienst rufen.
AUCH NACH DEM ABFLUSS WASSER IM TANK	Abflussleitung nicht richtig angebracht bzw. teilweise verstopft.	Sicherstellen, dass die Leitung nicht verstopft und der Abfluss nicht zu hoch angebracht ist. Siehe Anschlusschema.

- 1 Advertencias para la seguridad y el uso**
- 2 Características técnicas**
- 3 Instalación y posicionamiento**
- 4 instrucciones para el instalador**
- 5 Primera puesta en funcionamiento**
- 6 Instrucciones para el usuario modelos mecánicos**
- 7 Mantenimiento y limpieza (usuario)**
- 8 Problemas y anomalías (usuario)**

Le agradecemos por la elección del producto.  
Le aconsejamos leer atentamente todas las instrucciones contenidas en el manual para conocer las condiciones más idóneas para un uso correcto del lavavajillas.

#### **INSTRUCCIONES TÉCNICAS:**



Están destinadas al personal calificado que debe ejecutar la instalación, la puesta en servicio, la prueba y eventuales operaciones de asistencia.

#### **INSTRUCCIONES PARA EL USUARIO**

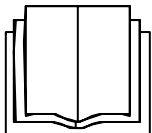

Indican los consejos de uso, la descripción de los mandos y las operaciones correctas de limpieza y mantenimiento del lavavajillas.

# 1 ADVERTENCIAS PARA LA SEGURIDAD Y EL USO



**ESTE MANUAL CONSTITUYE PARTE INTEGRANTE DEL LAVAVAJILLAS, POR LO TANTO, ES NECESARIO CONSERVARLO EN BUEN ESTADO JUNTO CON EL APARATO.**



**EL POSICIONAMIENTO, LAS CONEXIONES, LA PUESTA EN FUNCIONAMIENTO Y LA ELIMINACIÓN DE INCONVENIENTES Y LA SUSTITUCIÓN DEL CABLE DE ALIMENTACIÓN DEBEN SER EJECUTADOS POR PERSONAL CALIFICADO.**

EL LAVAVAJILLAS ESTÁ DESTINADO EXCLUSIVAMENTE A UN USO PROFESIONAL Y DEBE SER UTILIZADO POR PERSONAL HABILITADO. ESTÁ PREDISPUESA PARA EL LAVADO DE VAJILLAS (PLATOS, TAZAS, BOLS, SARTENES, CUBIERTOS) Y SIMILARES EN LOS SECTORES GASTRONÓMICOS Y EN EL RAMO DE LA RESTAURACIÓN COLECTIVA Y CUMPLE CON LAS NORMAS INTERNACIONALES DE SEGURIDAD ELÉCTRICA Y MECÁNICA (CEI-EN-IEC 60335-2-58/61770) Y DE COMPATIBILIDAD ELECTROMAGNÉTICA. (CEI-IEC-EN 55014-1/-2, 61000-3;4, 50366).

EL FABRICANTE **DECLINA TODA RESPONSABILIDAD** POR DAÑOS A PERSONAS O COSAS CAUSADOS **POR LA INOBSERVANCIA** DE LAS INSTRUCCIONES PRESENTES EN EL MANUAL, POR USO INCORRECTO, **MANIPULACIÓN** INCLUSO DE UNA SOLA PARTE DEL APARATO Y USO DE **REPUESTOS NO ORIGINALES**.



**ES OBLIGATORIA LA CONEXIÓN A TIERRA** SEGÚN LAS MODALIDADES PREVISTAS POR LAS NORMAS DE SEGURIDAD DE LA INSTALACIÓN ELÉCTRICA.

ESTE APARATO ESTÁ MARCADO EN CONFORMIDAD CON LA DIRECTIVA EUROPEA **2002/96/EC**, WASTE ELECTRICAL AND ELECTRONIC EQUIPMENT (WEE). ASEGURÁNDOSE DE QUE ESTE PRODUCTO SE ELIMINE DEL MODO CORRECTO, EL USUARIO CONTRIBUYE A PREVENIR LAS CONSECUENCIAS POTENCIALES NEGATIVAS PARA EL AMBIENTE Y LA SALUD.

EL SÍMBOLO  PRESENTE EN EL PRODUCTO O EN LA DOCUMENTACIÓN DE ACOMPAÑAMIENTO INDICA QUE ESTE PRODUCTO NO DEBE SER TRATADO COMO DESECHO DOMÉSTICO SINO QUE DEBE SER ENTREGADO A LOS PUNTOS DE RECOGIDA IDÓNEOS PARA EL RECICLADO DE APARATOS ELÉCTRICOS Y ELECTRÓNICOS.

DEJAR DE USAR EL APARATO SIGUIENDO LAS NORMAS LOCALES PARA LA ELIMINACIÓN DE LOS RESIDUOS.

PARA MAYORES INFORMACIONES SOBRE EL TRATAMIENTO, RECUPERACIÓN Y RECICLADO DE ESTE PRODUCTO, CONTACTAR LA OFICINA COMPETENTE LOCAL, EL SERVICIO DE RECOGIDA DE DESECHOS DOMÉSTICOS O EL NEGOCIO DONDE HA COMPRADO EL PRODUCTO.



**NO INTRODUCIR SOLVENTES COMO ALCOHOL O AGUARRÁS QUE PODRÍAN PROVOCAR UNA EXPLOSIÓN. NO INTRODUCIR VAJILLAS SUCIAS CON CENIZAS, CERA, PINTURAS.**



**NO UTILIZAR JAMÁS EL LAVAVAJILLAS O SUS PARTES COMO ESCALERA, SOPORTE O SOSTÉN DE PERSONAS, COSAS O ANIMALES.**

**APOYARSE O SENTARSE EN LA PUERTA ABIERTA DEL LAVAVAJILLAS PODRÍA CAUSAR SU VUELCO, CON EL CONSECUENTE PELIGRO PARA LAS PERSONAS.**

**NO DEJAR LA PUERTA DEL LAVAVAJILLAS ABIERTA YA QUE PODRÍA CONSTITUIR UN RIESGO DE TROPIEZOS.**



**NO BEBER EL AGUA RESIDUAL PRESENTE EN LA VAJILLA O EN EL LAVAVAJILLAS AL FINAL DEL PROGRAMA DE LAVADO.**



**EL APARATO NO ES ADECUADO PARA EL USO POR PARTE DE MENORES Y PERSONAS CON CAPACIDADES FÍSICAS, SENSORIALES O MENTALES REDUCIDAS, AUSENCIA DE EXPERIENCIA Y CONOCIMIENTO. LA UTILIZACIÓN DEL APARATO ESTÁ PERMITIDO A ESTAS PERSONAS SÓLO BAJO LA SUPERVISIÓN DE UNA PERSONA RESPONSABLE DE SU SEGURIDAD.**

## 2 CARACTERÍSTICAS TÉCNICAS

		<b>ADN408- ADN409</b>	<b>AGB648-AGB649- AGB650-AGB651- AGB652-AGB653- AGB654-AGB655- AGB656</b>	<b>AGB657-AGB658- AGB661-AGB662- AGB663-AGB653- AGB654</b>
Tensión de alimentación	V	400V/3+N 230V/1	400V/3+N 230V/1	400V/3+N 230V/1
Frecuencia	Hz	50	50	50
Potencia máx. absorbida	kW	4,9	4,9	5,1 – 6,6
Potencia resistencia hervidor	kW	4,5	4,5	4,5 - 6
Potencia resistencia tanque	kW	2,5	2,5	2
Potencia bomba de lavado	kW	0,4	0,4	0,6
Entrada agua de alimentación.	kPa	200-400	200-400	200-400
Temperatura agua de alimentación	°C	50 – 60	50 – 60	50 – 60
Temperatura del agua de alimentación "A" (suavizador incorporado)	°C	15 – 30	15 – 30	15 – 30
Dureza agua de alimentación	°dF	7 – 12	7 – 12	7 – 12
Consumo agua para ciclo de enjuague	l	2,4	2,4	2,4
Capacidad hervidor	l	7	7	7
Capacidad depósito	l	26	26	14,5
Duración ciclos estándar con alimentación del agua a 50°C	s	120	120/180	120/180
Nivel de rumorosidad	dB(A)	66	66	66
Grado de protección	IPX	4	4	4
Peso neto	kg	64	64	66
Tipo de cable de alimentación	◀HAK▶	H05VV-F	H05VV-F	H05VV-F

QUELLAVENASSELLER.COM

### 3 INSTALACIÓN Y POSICIONAMIENTO

#### INSTALACIÓN Y POSICIONAMIENTO

Llevar el lavavajillas al lugar de instalación, quitarlo del embalaje, comprobar el buen estado del aparato y de sus componentes, en el caso de daños, éstos deben ser comunicados por escrito al transportista.

Los elementos del embalaje (bolsas de plástico, poliestireno expandido, nylon, etc) no deben ser dejados al alcance de los niños y animales domésticos, por constituir fuentes potenciales de peligro.

Todos los materiales utilizados para el embalaje son compatibles con el ambiente. Éstos pueden conservarse sin peligro o ser eliminados en un centro de eliminación de residuos.

Los componentes de plástico sujetos a eliminación con reciclaje están marcados de los modos siguientes:

PE polietileno: película externa del embalaje, bolsa de instrucciones, bolsas de protección.

PP (polipropileno): precintos.

PS poliestireno expandido: esquineros de protección, tapa de embalaje.

Los componentes de madera y cartón pueden eliminarse respetando las normas vigentes.

Al dejar de usar el producto, evitar de dispersarlo en el ambiente; la eliminación debe realizarse en el respeto de las normas vigentes. Todas las partes metálicas son de acero inoxidable y desmontables.

Las partes de plástico están marcadas con el símbolo del relativo material.

#### POSICIONAMIENTO:



**Atención:** la instalación interna y los locales donde se instalan los aparatos para comunidad, deben responder a las normativas vigentes.

El fabricante declina toda responsabilidad por daños directos o indirectos a personas o cosas que deriven de la inobservancia de dichas normativas.

Antes de la instalación, comprobar que en las cercanías no haya o estén adecuadamente protegidos, objetos y materiales que podrían dañarse por el vapor o por salpicaduras de solución de lavado.

Posicionar el lavavajillas en el punto deseado y quitar la película protectora.

Nivelar el lavavajillas (ayudándose con una burbuja de nivel) en los cuatro pies regulados de modo tal de garantizar su estabilidad; toda otra solución debe ser aprobada por el fabricante.

### 4 INSTRUCCIONES PARA EL INSTALADOR

#### CONEXIÓN HIDRÁULICA Y DESCARGA:

Los tubos hidráulicos y el cable de alimentación eléctrica salen desde la zona posterior. Conectar el tubo de alimentación hídrica a una toma con boca roscada 3/4" gas.

Para la conexión a la red hídrica utilizar solo tubos nuevos; los tubos viejos o usados no deben utilizarse.

La **presión dinámica de alimentación** deberá estar comprendida entre 2 y 4 bar, si es superior es necesario instalar un reductor de presión.

Es indispensable instalar una llave general en la tubería de llegada del agua de alimentación; dicha llave deberá estar accesible una vez terminada la instalación; no instalar la llave de paso detrás del lavavajillas.

La duración declarada de los ciclos se refiere a la alimentación con **agua caliente a 50°C**.

En el caso de alimentación con agua fría, la duración ciclos podría aumentar en relación a la temperatura del agua entrante, estando la lavavajillas dotada de enjuague a temperatura y presión constantes.

#### DESCARGA

Cada lavavajillas está ya dotada de un tubo para la conexión a la descarga; esto deberá preverse en el suelo con pileta de sifón.



**Atención:** asegurarse que los tubos de alimentación y descarga no estén doblados, estrangulados o aplastados después de la instalación.





## 4.1 Conexión eléctrica

La conexión eléctrica del lavavajillas y eventuales aparatos suplementarios debe encomendarse a personal autorizado y calificado, en el respeto de las normas vigentes; observar además las disposiciones técnicas de conexión.

La potencia total instalada está indicada en la placa de datos técnicos del aparato.

Junto con el lavavajillas no deben estar protegidos otros aparatos.

El comerciante deberá realizar la instalación según las normas vigentes, de un interruptor general en la línea de alimentación eléctrica y de un interruptor diferencial compatible con las características de la máquina.

Dichos interruptores deben instalarse cerca del lavavajillas, ser fácilmente accesibles después de la instalación y garantizar la desconexión completa de la red eléctrica en las condiciones de la categoría de sobretensión III.



### !!!ATENCIÓN!!!

El lavavajillas no está alimentado únicamente cuando está desconectado el interruptor general.

- Conectar el aparato al sistema equipotencial. El borne  $\nabla$  para la conexión está situado en la zona posterior inferior de la máquina.
- El conductor de protección (PE) es de color amarillo-verde, el conductor neutro (N) de color azul y los conductores de fase (L1, L2, L3) de color negro, gris y marrón.

## 5 PRIMERA PUESTA EN FUNCIONAMIENTO (Instalador)

### PRIMERA PUESTA EN FUNCIONAMIENTO

El sistema eléctrico de protección debe someterse a una prueba funcional antes de la puesta en funcionamiento. La instalación debe ser ejecutada y/o comprobada por el revendedor autorizado que se ocupará de la primera puesta en funcionamiento y de las instrucciones relativas al funcionamiento del lavavajillas.

### PREPARACIÓN PARA EL USO

#### Importante:

El dosificador abrillantador está siempre presente, el dosificador de detergente solamente en algunos modelos.

**Si ambos dosificadores están presentes**, posicionar los recipientes externos de detergente y abrillantador e introducir los respectivos tubos de calada situados en la parte posterior de la máquina.

Tubo rojo: detergente

tubo transparente: abrillantador

Antes de introducir los tubos en los recipientes aplicar en los extremos el peso (necesario para mantener el calada en el fondo del recipiente) y el filtro como se indica en la figura.

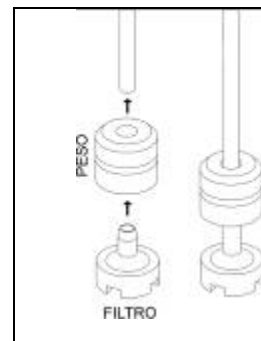
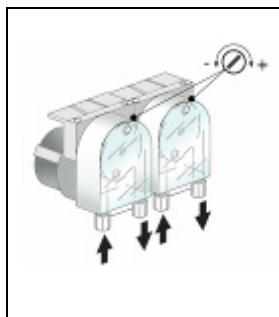

Para la regulación usar los tornillos de regulación indicados en la figura, se aconseja hacer ejecutar la regulación por personal perteneciente a las sociedades proveedoras de productos detergentes.

Si el dosificador de detergente no está premontado, se lo puede instalar con posterioridad ordenando el relativo KIT.

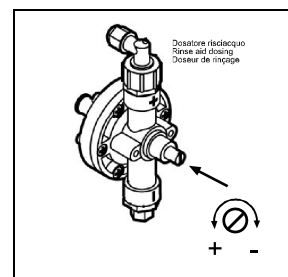

En alternativa, se puede conectar un dosificador externo ejecutando su conexión eléctrica con un cable 2x0,5 mm tipo H05 RN-F, introducido a través del paso indicado en el diagrama CARACTERÍSTICAS TÉCNICAS y conectado como se indica en el diagrama eléctrico en dotación con el lavavajillas.

El dosificador debe ser 230V/50 Hz con potencia máxima absorbida de 15 W.

Conectar al dosificador detergente exterior al lavavajillas a través del tubo rojo arriba citado.



## 6 INSTRUCCIONES PARA EL USUARIO

AGB 648/WP- AGB 650/DP- AGB 650/WP- AGB 654/DP- AGB 654/WP- AGB 656/WP- AGB 657/WP- AGS 653/WP- AGB 661/DP- AGB 661/WP- AGB 663/WP

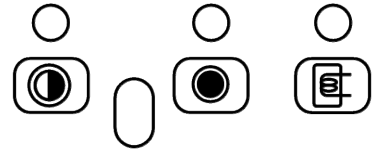
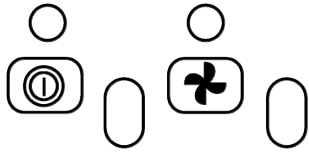

AGB 649/WP- AGB 651/DP- AGB 651/WP- AGB 655/DP- AGB 658/WP- AGS 654/WP- AGB 662/DP- AGB 662/WP

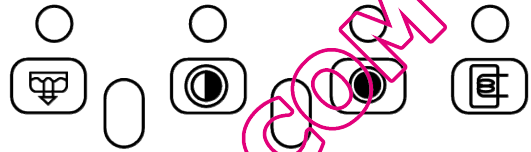
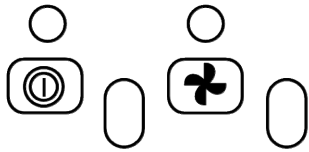

AGB 653/DP- AGB 653/WP

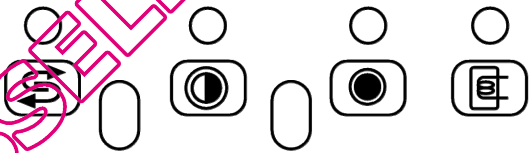
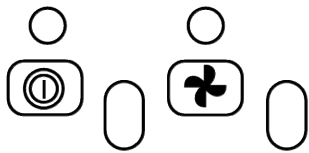

AGB 652/DP- AGB 652/WP

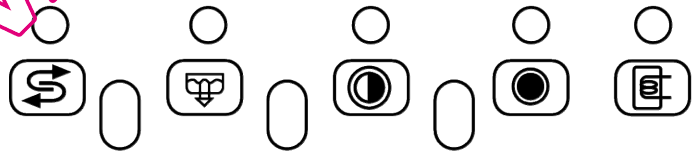
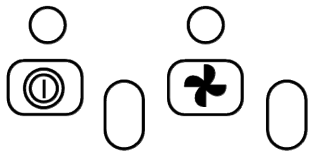



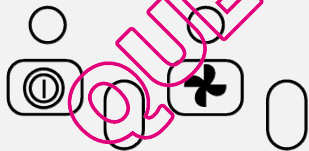



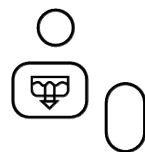
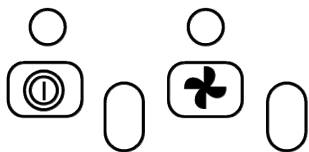

ADN408



ADN409



	Símbolo botón de on/off		Lámparas testigo funciones
	Símbolo botón ciclo lavado		Símbolo botón bomba de descarga
	Símbolo botón regeneración		Símbolo lámpara testigo hervidor enjuague
	Simbolo ciclo breve		Simbolo ciclo medio

## 6.1 Antes del lavado

Usar solamente detergentes y abrillantadores para lavavajillas industriales.

No utilizar detergentes previstos para el lavado a mano.



Aconsejamos la utilización de productos específicamente estudiados para este tipo de lavavajillas.



Durante el llenado de los tanques, prestar atención de no intercambiar los productos, esto podría provocar malfuncionamientos y daños a la lavavajillas.

No mezclar detergentes diferentes, se dañaría el dispositivo dosificador.

Los detergentes para lavavajillas industriales pueden provocar graves irritaciones. Respetar atentamente las instrucciones del productor de detergentes indicados en el envase.

Abrir la llave del agua de red.	Comprobar:		Activar el interruptor general, en el display aparece "OFF"
	El nivel de detergente y abrillantador en los contenedores.	El posicionamiento correcto de los filtros, la rotación de los rociadores, la ausencia de cuerpos extraños en el lavavajillas	
			

## 6.2 Carga de la vajilla

### PLATOS

El cestillo puede contener

**12 platos hondos** o **18 platos playos**.

Quitar los residuos sólidos de los platos (huesos, cáscaras, carozos, etc); dejar en remojo en agua frío los platos con residuos secos de queso, huevo, etc,

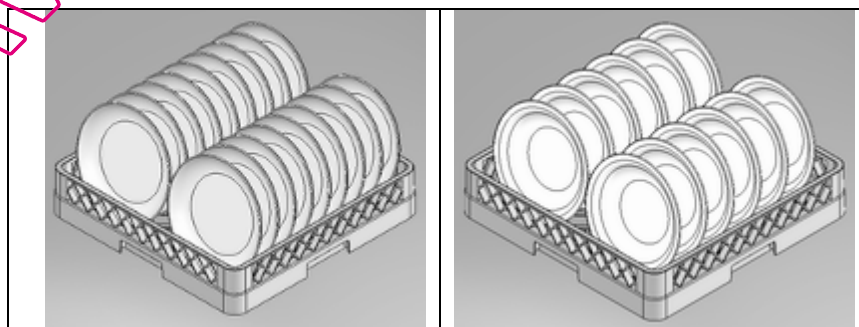

### CARGA DE LOS VASOS











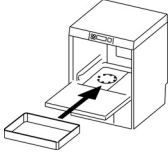

Quitar los posibles residuos sólidos (cáscaras, carozos, etc) presentes en los vasos.

Colocar los vasos mirando hacia abajo.

### CUBIERTOS

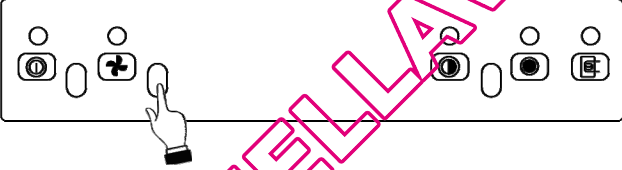
Utilizar el respectivo cestillo. Disponer los cubiertos en desorden preferiblemente con el mango dirigido hacia abajo, prestando atención de no herirse con los dientes de los tenedores y las hojas de los cuchillos.

### 6.3 PRIMER USO DIARIO (Cubeta y hervidor vacíos)

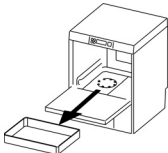
El panel visualizado en el manual y la gráfica podrían mostrar funciones no presentes en vuestra máquina.	Acciones y qué sucede
	<p>Accionar el interruptor de pared, abrir la puerta introducir el rebose, cerrar la puerta:</p> <p>Pulsar el botón <b>on/off</b> , la lámpara testigo se enciende, carga agua en hervidor y en la cubeta. Cuando se ha efectuado la carga del hervidor y de la cubeta se enciende la luz testigo hervidor </p>
	<p>Cargar el cestillo</p>
	<p>Seleccionar el programa deseado pulsando:</p> <p> Ciclo breve oppure</p> <p> Ciclo medio</p>
	<p>Esperar que la lámpara testigo hervidor  se apaga. Para arrancar el ciclo de lavado pulsar el botón ciclo </p>
	<p>Ciclo en curso, la lámpara testigo ciclo se enciende. Si se abre la puerta durante el ciclo el programa se detiene, cuando se vuelve a cerrar el programa se pone en cero. Para volver a arrancar, pulsar nuevamente el botón del ciclo </p>
	<p>Al terminar el programa, la lámpara testigo ciclo se apaga y se encenderá la lámpara testigo hervidor </p>
	<p>Descargar el cestillo</p>

## 6.4 CICLO RESINAS (para modelos provistos de suavizador agua)

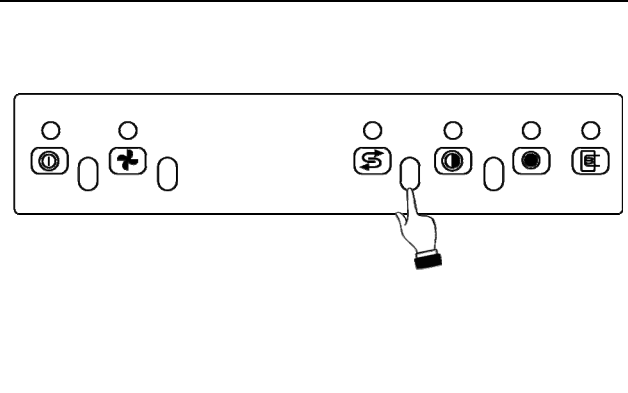
	<p>Con la máquina apagada abrir la puerta y <b>quitar el rebose para vaciar la cubeta; una vez vaciada la cubeta volver a colocar el rebose</b> y cerrar la puerta.</p> <p>Pulsar la tecla <b>S</b> la lámpara testigo se enciende y el ciclo de regeneración arranca, después de 20 minutos el ciclo de regeneración termina y la máquina permanece apagada. Abrir la puerta, comprobar que el agua de regeneración esté en la cubeta, quitar el rebose para vaciar la cubeta; una vez vaciada la cubeta volver a colocar el rebose y cerrar la puerta. Desconectar el interruptor general de pared.</p>
---	---

Durante la ejecución del ciclo de regeneración no será posible ejecutar ninguna operación, siempre debe realizarse con el tanque vacío.

### Reabastecimiento sal regenerante (para modelos provistos de suavizador agua)





Ejecutar el abastecimiento de la sal **cuando no hay agua en la cesta** para evitar que el agua de lavado entre en el dispositivo suavizador del agua; extraer siempre el enchufe de alimentación de la toma de red antes de realizar la operación. Recordarse de volver a conectar la toma de alimentación en la toma después de haber realizado la operación.

**Atención: usar sólo sal específico, no utilizar sal comestible.**

El tanque de la sal tiene una capacidad de **1 kg de sal gruesa**.

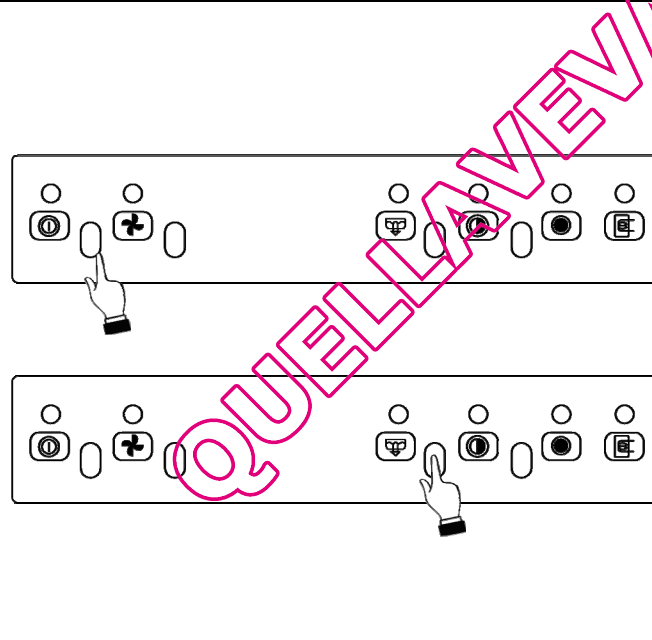
El tanque está situado en el fondo del tanque. Después de haber extraído el cestillo, desenroscar el tapón y verter la sal utilizando el embudo en dotación. Antes de enroscar nuevamente el tapón extraer los residuos de sal en proximidad de la apertura.

## 6.5 Descarga total al final de la jornada

	<p><b>Descarga total al final de la jornada (modelos con bomba de descarga)</b></p> <p>Apagar la máquina pulsando el botón <b>on/off</b> , abrir la puerta quitar el rebose, mantener presionado el botón de bomba de descarga  hasta que se vacíe totalmente la cubeta.</p> <p>Para poner nuevamente en funcionamiento la máquina se debe colocar el rebose en la cubeta, cerrar la puerta y pulsar el botón <b>on/off</b> , o en el caso de fin de servicio, desconectar el interruptor general de pared.</p> <p><b>Descarga total al final de la jornada (modelos sin bomba de descarga)</b></p> <p>Apagar la máquina pulsando el botón <b>on/off</b> , abrir la puerta quitar el rebose y esperar que se vacíe totalmente la cubeta. Volver a colocar el rebose y cerrar la puerta. Desconectar el interruptor general de pared.</p>
---	--

No apagar la lavavajillas con agua en el tanque, ejecutar siempre la descarga. Al final del servicio, después de haber realizado la descarga final y la eventual regeneración, apagar la máquina pulsando



el interruptor **on/off** , desarmar el interruptor de pared y cerrar el grifo de interceptación del agua. No dejar el aparato inactivo encendido e inutilizado por períodos de tiempo más o menos prolongados.

## 7 MANTENIMIENTO Y LIMPIEZA

No obstante, no sea necesaria un mantenimiento particular programado aconsejamos hacer controlar la lavavajilla por un técnico especializado dos veces por año.

**NOTA:** daños intencionales o derivados de incuria, negligencia, inobservancia de las prescripciones, instrucciones y normas o por conexiones erróneas, no serán responsabilidad del fabricante.

### 7.1 Limpieza cotidiana

La lavavajillas responde al grado de protección **IPX4**, pero está **prohibido** utilizar chorros de agua directos para la limpieza.

#### LIMPIEZA DEL FILTRO DURANTE LA JORNADA

Se aconseja, en caso de utilización particularmente gravoso, efectuar cada 30-40 ciclos la limpieza del filtro, manteniendo la máquina en condiciones operativas; para ello, ejecutar la “descarga parcial del tanque”.

Quitar los filtros (es suficiente alzarlos de su asiento como se indica en la figura), prestando atención que los residuos grandes no caigan en el colector debajo de los filtros, limpiarlos de los residuos y enjuagarlos abundantemente, recolocándolos después correctamente, no intervenir con objetos puntiagudos y cortantes.

Limpiar eventuales incrustaciones de cal para evitar acumulaciones;

- Limpiar cuidadosa y frecuentemente las superficies con un paño húmedo, utilizar detergentes neutros, no abrasivos, que no contengan sustancias a base de cloro, productos que corroen y dañan el acero inox.

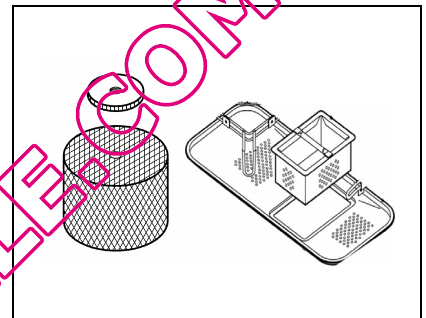

No utilizar los productos arriba enumerados ni siquiera para limpiar el suelo debajo del lavavajillas o en las cercanías, para evitar que vapores o gotas puedan producir daños a las superficies de acero.

### 7.2 Controles periódicos

Desmontar los irrigadores (inferior y superior 2-4), desenroscando el tornillo central (4); desenroscar los tapones de los dos extremos de lavado (7).

Limpiar los orificios de las toberas bajo un chorro de agua corriente limpia, no intervenir con herramientas que podrían provocar daños. Volver a montar con atención los rociadores.

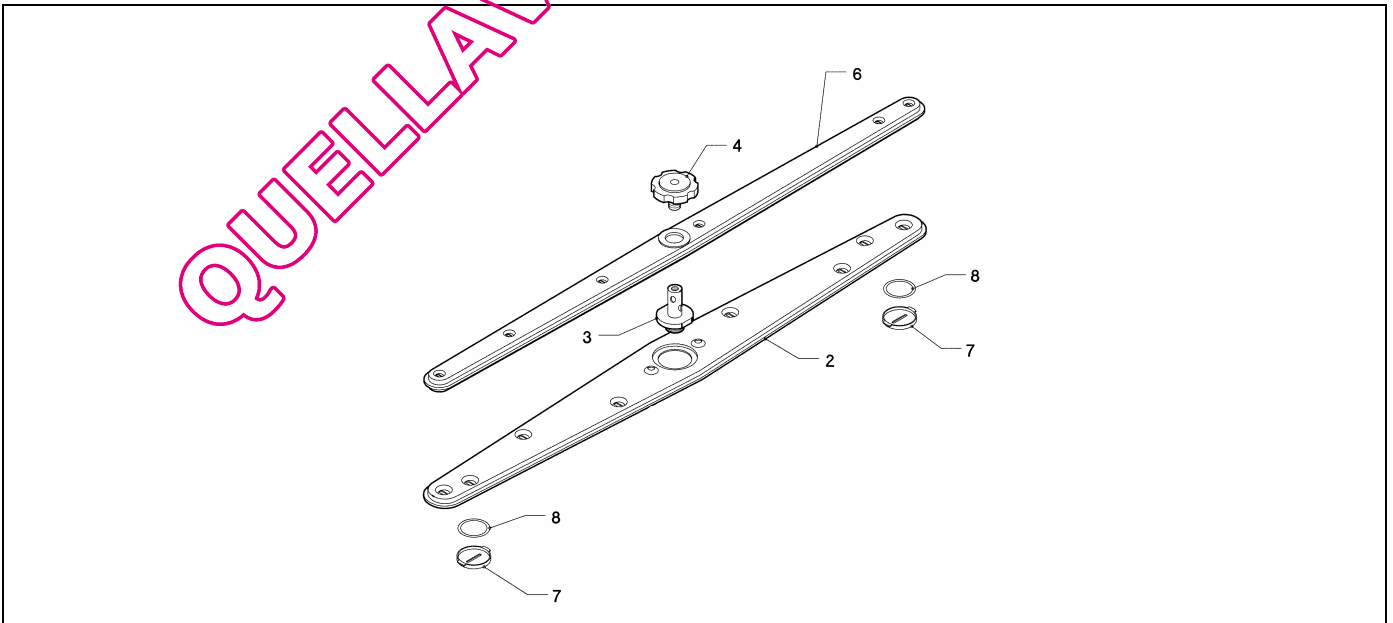

Limpiar externamente la máquina con un paño húmedo y jabón neutro enjuagando y secando atentamente.

### 7.3 Paro prolongado

Si se prevé de no utilizar el lavavajillas por un período de tiempo prolongado, **se debe ejecutar el vaciado del dispositivo de erogación de detergente y abrillantador para evitar cristalizaciones y daños en las bombas.** Quitar los tubos de calado de los contenedores del detergente y abrillantador y sumergirlos en un contenedor con agua limpia, ejecutar algunos ciclos de lavado, ejecutar la descarga completa.

Por último, desconectar el interruptor general, cerrar la llave de entrada del agua, los tubos de calado detergente y abrillantador deberán introducirse nuevamente al momento de la puesta en funcionamiento, **prestando atención de no invertirlos (tubo rojo = detergente; tubo transparente = abrillantador).**

**No dejar el aparato inactivo encendido e inutilizado por períodos de tiempo más o menos prolongados.**



## 8 PROBLEMAS Y ANOMALÍAS (USUARIO)

PROBLEMA	CAUSA POSIBLE	POSIBLE SOLUCIÓN
NO SE ENCIENDE EL INDICADOR LUMINOSO LÍNEA	Falta tensión en la red	Comprobar la conexión a la red eléctrica.
EL PROGRAMA DE LAVADO NO ARRANCA	El llenado de la lavavajillas no ha terminado aún	Esperar que la lámpara testigo hervidor se encienda.
RESULTADOS DE LAVADO PÉSIMOS	Orificios de lavado de los rociadores atascados o incrustados.	Desmontar y limpiar los rociadores. (10.2 Controles periódicos)
	Detergente o abrillantador insuficiente o inadecuado.	Comprobar el tipo y la cantidad de detergente.
	Platos/vasos mal posicionados	Disponer adecuadamente platos/vasos.
	Baja temperatura de lavado	Comprobar la temperatura visualizada en el display, si es inferior a 50° llamar a la asistencia.
	Ciclo configurado inadecuado	Aumentar la duración del ciclo de lavado, en especial, si está muy sucio o parcialmente seco.
ENJUAGUE INSUFICIENTE	Toberas rociadores obstruidas. Hervidor incrustado de cal.	Comprobar la limpieza de las toberas y si funciona bien el suavizador eventualmente montado.
VASOS Y CUBIERTOS MANCHADOS	Abrillantador inadecuado o no erogado correctamente. Dureza del agua superior a 12° o muchas sales disueltas.	Comprobar el contenedor del abrillantador y si es adecuado al tipo de agua de red. Si el problema permanece, contactar a la asistencia.
PRESENCIA DE AGUA EN EL TANQUE DESPUÉS DE LA DESCARGA	Tubo de descarga mal posicionado o parcialmente obstruido.	Comprobar que el tubo y la descarga de lavavajillas no estén obstruidos y que la descarga no esté posicionada demasiado arriba; ver esquema de conexión.

- 1 Advertências para a segurança e para o uso**
- 2 Características técnicas**
- 3 Instalação e posicionamento**
- 4 instruções para o instalador**
- 5 Antes da entrada em funcionamento**
- 6 Instruções para o utente modelos mecánicos**
- 7 Manutenção e limpeza (utente)**
- 8 Problemas e anomalias (utente)**

Agradecemos-lhe por ter escolhido o nosso produto.  
Aconselhamos de lêr atentamente todas as instruções contidas no manual para conhecer as condições mais idóneas para uma correcta utilização da máquina de lavar loiça.

#### **INSTRUÇÕES TÉCNICAS:**



Estão destinadas ao pessoal qualificado que deve efectuar a instalação, a entrada em funcionamento, o controle, e eventuais intervenções de assistência.

#### **INSTRUÇÕES PARA O UTENTE:**

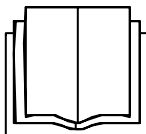

Indicam os conselhos para o uso, a descrição dos comandos e as correctas operações de limpeza e manutenção da máquina de lavar loiça.



# 1 ADVERTÊNCIAS PARA A SEGURANÇA E O USO



**ESTE MANUAL CONSTITUI PARTE INTEGRANTE DA MÁQUINA DE LAVAR LOIÇA; DEVE SER CONSERVADO SEMPRE ÍNTEGRO JUNTAMENTE COM A MÁQUINA.**



O POSICIONAMENTO, AS LIGAÇÕES, E ENTRADA EM FUNCIONAMENTO E ELIMINAÇÃO DOS INCONVENIENTES, E A SUBSTITUIÇÃO DO CABO DE ALIMENTAÇÃO DEVEM **SER EFECTUADAS POR PESSOAL QUALIFICADO.**

A MÁQUINA DE LAVAR LOIÇA FOI DESTINADA EXCLUSIVAMENTE PARA O USO PROFISSIONAL E DEVE SER UTILIZADA POR PESSOAL HABILITADO. ESTÁ PREDISPOSTA PARA A LAVAGEM DE LOIÇA (PRATOS, TAÇAS, CHÁVENAS, TABULEIROS, TALHERES) E SIMILARES NOS SECTORES GASTRONÓMICOS E NO RAMO DA RESTAURAÇÃO COLECTIVA, E ESTÁ EM CONFORMIDADE COM AS NORMAS INTERNACIONAIS DE SEGURANÇA ELÉCTRICA E MECÂNICA (**CEI-EN-IEC 60335-2-58/61770**) E DE COMPATIBILIDADE ELECTRO-MAGNÉTICA (**CEI-IEC-EN 55014-1/-2, 61000-3;4, 50366**).

O CONSTRUTOR **DECLINA QUALQUER RESPONSABILIDADE** POR DANOS A PESSOAS OU A COISAS CAUSADOS **PELA INOBSERVÂNCIA** DAS INSTRUÇÕES PRESENTES NO MANUAL, PELO **USO INCORRECTO**, PELA **ALTERAÇÃO** MESMO DE UMA SÓ PARTE DA MÁQUINA E DO UTILIZO DE **PEÇAS DE REPOSIÇÃO NÃO ORIGINAIS**.



É **OBRIGATÓRIA A LIGAÇÃO À TERRA** EM CONFORMIDADE COM AS MODALIDADES PREVISTAS PELAS NORMAS DE SEGURANÇA DA INSTALAÇÃO ELÉCTRICA.

ESTA MÁQUINA ESTÁ MARCADA EM CONFORMIDADE COM AS DIRECTIVAS EUROPÉIAS **2002/96/EC**, WASTE ELECTRICAL AND ELECTRONIC EQUIPMENT (WEE).

ASSEGURAR-SE QUE ESTE PRODUTO SEJA ELIMINADO DE MODO CORRECTO O UTENTE CONTRIBUI PARA PREVENIR AS POTENCIAIS CONSEQUÊNCIAS NEGATIVAS PARA O AMBIENTE E PARA A SAÚDE.

O SÍMBOLO  NO PRODUTO OU NA DOCUMENTAÇÃO DE ACOMPANHAMENTO INDICA QUE ESTE PRODUTO DEVE SER TRATADO COMO RESÍDUO DOMÉSTICO MAS DEVE SER ENTREGUE NUM IDÓNEO PONTO DE RECOLHA PARA A RECICLAGEM DE APARELHOS ELÉCTRONICOS.

INUTILIZAR A MÁQUINA SEGUINDO AS NORMAS LOCAIS PARA A ELIMINAÇÃO DE RESÍDUOS. PARA MAIS INFORMAÇÕES SOBRE O TRATAMENTO, RECUPERAÇÃO E RECICLAGEM DESTA MÁQUINA, CONTACTAR O COMPETENTE ESCRITÓRIO LOCAL, O SERVIÇO DE RECOLHA DE RESÍDUOS DOMÉSTICOS OU O ESTABELECIMENTO COMERCIAL ONDE FOI COMPRADA A MÁQUINA.



NÃO INTRODUIZIR SOLVENTES COMO ÁCOOL OU TEREBINTINA QUE PODEM PROVOCAR UMA EXPLOSAO. NÃO INTRODUIZIR LOIÇA SUJA DE CINZAS, CERA, VERNIZES.



NÃO UTILIZAR JAMAIS A MÁQUINA DE LAVAR LOIÇA COMO ESCADA, SUPORTE OU SUSTENTAÇÃO PARA PESSOAS OU ANIMAIS.

APOIAR-SE OU SENTAR-SE NA PORTA ABERTA DA MÁQUINA DE LAVAR LOIÇA PODE CAUSAR O REVIRAMENTO, COM CONSEQUENTE PERIGO PARA AS PESSOAS.

NÃO DEIXAR A PORTA DA MÁQUINA DE LAVAR LOIÇA ABERTA PORQUE PODE FAZER TROPEÇAR ALGUÉM.



NÃO BEBER ÁGUA RESÍDUA EVENTUALMENTE PRESENTE NA LOIÇA OU NA MÁQUINA DE LAVAR LOIÇA NO FINAL DO PROGRAMA DE LAVAGEM.



A MÁQUINA NÃO DEVE SER UTILIZADA POR MENORES E POR PESSOAS COM UMA REDUZIDA CAPACIDADE FÍSICA, SENSORIAL OU MENTAL, COM FALTA DE EXPERIÊNCIA OU DE CONHECIMENTO. A UTILIZAÇÃO DA MÁQUINA É CONSENTIDA A ESTAS PESSOAS SÓMENTE COM A SUPERVISÃO DE UMA PESSOA RESPONSÁVEL PELA SUA SEGURANÇA.

## 2 CARACTERÍSTICAS TÉCNICAS

		ADN408-ADN409	AGB648-AGB649- AGB650-AGB651- AGB652-AGB653- AGB654-AGB655- AGB656	AGB657-AGB658- AGB661-AGB662- AGB663-AGB653- AGB654
Tensão de alimentação	V	400V/3+N 230V/1	400V/3+N 230V/1	400V/3+N 230V/1
Frequência	Hz	50	50	50
Potência máx. absorvida	kW	4,9	4,9	5,1 – 6,6
Potência resistência esquentador	kW	4,5	4,5	4,5 - 6
Potência resistência tanque	kW	2,5	2,5	2
Potência bomba lavagem	kW	0,4	0,4	0,6
Pressão água alimentação	kPa	200-400	200-400	200-400
Temperatura água alimentação	°C	50 – 60	50 – 60	50 – 60
Temperatura água alimentação versões "A" (amaciador incorporado)	°C	15 – 30	15 – 30	15 – 30
Dureza água alimentação	°dF	7 – 12	7 – 12	7 – 12
Consumo água para ciclo de passagem por água	l	2,4	2,4	2,4
Capacidade esquentador	l	7	7	7
Capacidade tanque	l	26	26	14,5
Duração ciclos standard com alimentação água a 50°C	s	120	120/180	120/180
Nível ruído	dB(A)	66	66	66
Grau de protecção	IPX	4	4	4
Peso líquido	kg	64	64	66
Tipo de cabo de alimentação	◀HAR▶	H05VV-F	H05VV-F	H05VV-F

### 3 INSTALAÇÃO E POSICIONAMENTO

#### INSTALAÇÃO E POSICIONAMENTO

Levar a máquina de lavar loiça para o local de instalação, remover a embalagem, verificar a integridade da mesma e dos seus componentes, no caso de danos estes devem ser notificados por escrito ao transportador. Os elementos de embalagem (sacos de plástico, polistireno expansivo, pregos, etc.) não devem ser deixados ao alcance de crianças ou de animais domésticos, porque são potenciais fontes de perigo.

Todos os materiais utilizados para a embalagem são compatíveis com o ambiente. Os mesmos podem ser conservados sem perigo, ou ser desmontados num apropriado centro de destruição de resíduos.

Os componentes em material plástico sujeitos a eventual desmontagem com reciclagem são marcados da seguinte forma:

PE polieteno: película externa embalagem, saco instruções, sacos de protecção.

PP polipropeno: arco de ferro.

PS polistireno expansivo: angulares de protecção, cobertura embalagem..

Os componentes em madeira e cartão podem ser destruídos respeitando as normas em vigor. Ao inutilizar o produto evitar o desperdício no ambiente; o desmontamento deve efectuar-se respeitando as normas em vigor. Todas as peças metálicas são de aço inoxidável e desmontáveis. As peças em plástico estão marcadas com o símbolo do relativo material.

#### POSICIONAMENTO:



**Atenção:** a instalação interna e os locais onde são instaladas as máquina por comunidades, devem responder às normas em vigor.

O construtor declina qualquer responsabilidade por danos directos ou indirectos a pessoas ou a coisas derivantes da não observância das ditas normativas.

Antes de instalar verificar se nas proximidades não existem ou estejam adequadamente protegidos, objectos e materiais que poderão ser danificados pelo vapor da água ou por salpicos de soluções de lavagem.

Posicionar a máquina de lavar loiça no ponto desejado e retirar a película protectora.

Nivelar a máquina (com a ajuda de um nível de bolhas de ar) nos quatro pés regulados de modo a garantir a estabilidade; qualquer outra solução deve ser aprovada pelo construtor.

### 4 INSTRUÇÕES PARA O INSTALADOR

#### LIGAÇÃO HIDRÁULICA E DESCARGA:

Os tubos hidráulicos e o cabo de alimentação eléctrica saem da zona posterior. Ligar o tubo de alimentação hídrica a uma tomada com boca roscada  $\frac{3}{4}$ " gas.

Para a ligação á rede hídrica utilizar sómente tubos novos; tubos velhos ou usados não devem ser utilizados.

A **pressão dinâmica de alimentação** deve ser compreendida entre **2 e 4 bar**, se fôr superior é necessário instalar um redutor de pressão.

É indispensável instalar uma torneira geral na tubagem de chegada de água de alimentação; a torneira deverá ser acessível á instalação terminada, não instalar a torneira atrás da máquina de lavar loiça.

A duração dos ciclos declarada refere-se á alimentação com **água quente 50°C**.

No caso de alimentação com água fria a duração poderá aumentar em relação á temperatura da água de entrada, sendo a máquina de lavar loiça equipada com passagem por água a temperatura e pressão constantes.

#### DESCARGA:

Cada máquina de lavar loiça já está equipada com tubo de ligação á descarga; este deverá ser previsto para o pavimento, com tubo sifão.



**Atenção:** assegurar-se que os tubos de alimentação e descarga não estejam dobrados, obstruídos ou esmagados após a instalação.



## 4.1 Ligação eléctrica

A ligação eléctrica da máquina de lavar loiça e da eventual aparelhagem suplementar deve ser efectuada por pessoal autorizado e qualificado, com respeito com as normas em vigôr; observar também as disposições técnicas de ligação.

A potência total instalada está alistada na placa de dados técnicos da máquina.

Juntamente com a máquina não devem ser protegidos outros aparelhos.

O utente deve providenciar á instalação, conforme as normas em vigôr, de um interruptor geral na linha de alimentação eléctrica e de um interruptor diferencial compatível com as características da máquina.

Tais interruptores devem ser instalados perto da máquina, devem ser facilmente acessíveis após a instalação e garantir a desligação completa da rede eléctrica em condições de categoria de sobretensão III.



### Atenção!!!

A máquina não tem tensão sómente quando o interruptor geral estiver desactivado.

- Ligar o aparelho ao sistema equipotencial de uso. O borne ⚡ para a ligação está posto na zona posterior inferior da máquina.
- O condutor de protecção (PE) é de côr amarelo-verde, o condutor neutro (N) é de côr azul e os condutores de fase (L1, L2, L3) são de côr preto, cinza e castanho.

## 5 ANTES DA ENTRADA EM FUNCIONAMENTO (Instalador)

### PRIMEIRA ENTRADA EM FUNCIONAMENTO

O sistema eléctrico de protecção deve ser sujeito a um teste funcional antes da entrada em funcionamento. A instalação deve ser efectuada e/ou verificada pelo revendedor autorizado que se ocupará da primeira entrada em funcionamento e das instruções relativas ao funcionamento da máquina de lavar loiça.

### PREPARAÇÃO PARA O USO

#### Importante:

O doseador abrillantante está sempre presente, o doseador detergente sómente para alguns modelos.

**Se ambos os doseadores estiverem presentes** posicionar os recipientes externos de detergente e abrillantante e inserir-lhes os respectivos tubos de imersão postos por trás da máquina.

Tubo vermelho: detergente  
tubo trasparente: abrillantante

Antes de introduzir os tubos nos recipientes aplicar nas extremidades o peso (necessário para mantêr a imersão no fundo do recipiente) e o filtro conforme indicado na figura.

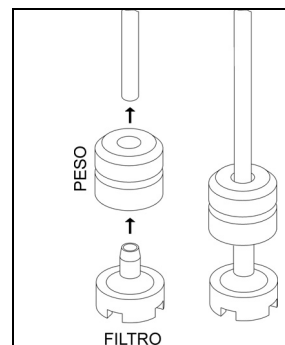
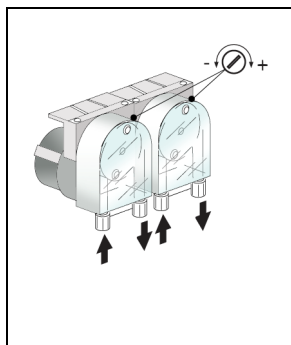

Para a regulação usar os parafusos de regulação indicadas na figura, recomenda-se de fazer efectuar a regulação ao pessoal da sociedade fornecedora dos produtos de detergentes.

Se o doseador detergente não foi pré-montado, é possível instalá-lo sucessivamente pedino o KIT relativo.

Em alternativa é possível adaptar um doseador externo efectuando a ligação eléctrica com um cabo 2x0,5 mm tipo H05 RN-F, inserido através da passagem indicada no esquema CARACTERÍSTICAS TÉCNICAS e ligada conforme o esquema eléctrico em dotação com a máquina de lavar loiça.

O doseador deve ser 230V/50 Hz com potência máxima absorvida de **15 W**.

Ligar ao doseador detergente externo á máquina através do tubo vermelho supracitado.

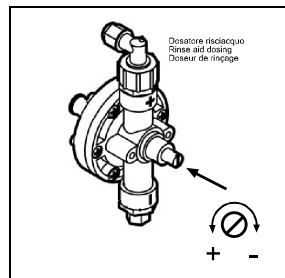

## 6 INSTRUÇÕES PARA O UTENTE

AGB 648/WP- AGB 650/DP- AGB 650/WP- AGB 654/DP- AGB 654/WP- AGB 656/WP- AGB 657/WP- AGS 653/WP- AGB 661/DP- AGB 661/WP- AGB 663/WP

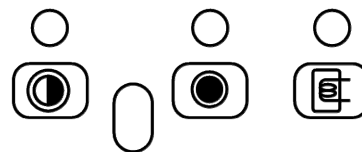
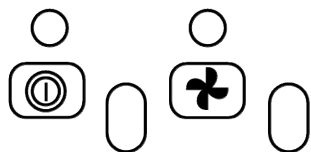

AGB 649/WP- AGB 651/DP- AGB 651/WP- AGB 655/DP- AGB 658/WP- AGS 654/WP- AGB 662/DP- AGB 662/WP

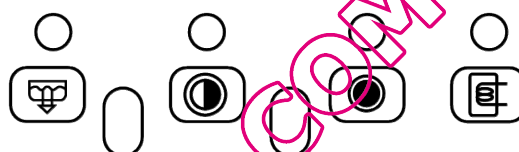
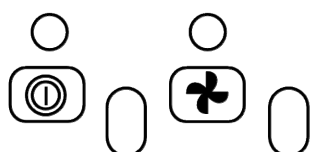

AGB 653/DP- AGB 653/WP

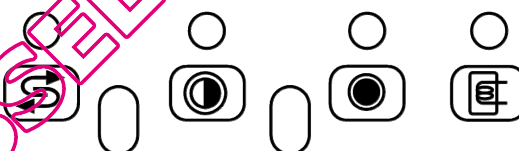
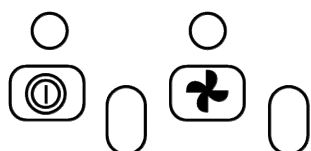

AGB 652/DP- AGB 652/WP

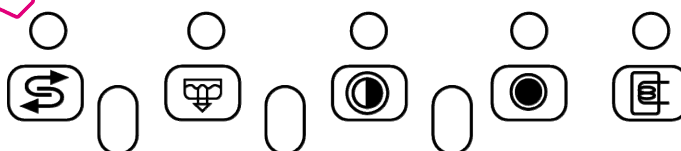
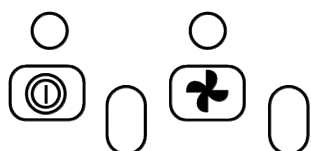



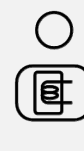
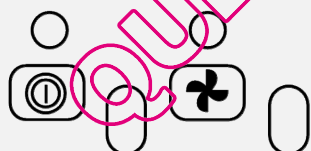



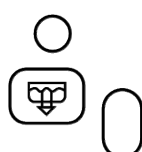
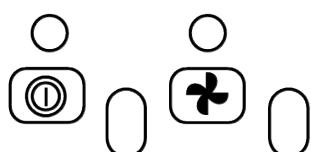

ADN408



ADN409



	Símbolo botão on/off		Lâmpadas de sinalização funções
	Símbolo botão ciclo lavagem		Símbolo botão bomba descarga
	Símbolo botão regeneração		Símbolo lâmpada de sinalização esquentador passagem por água
	Simbolo ciclo breve		Simbolo ciclo medio

## 6.1 Antes da lavagem

Use unicamente detergentes e abrillantadores para máquinas de lavar louça industriais.



Não utilize detergentes previstos para a lavagem à mão.

Aconselhamos a utilização de produtos especificamente estudados para esta máquina de lavar louça.

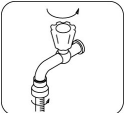

Durante o abastecimento dos depósitos preste atenção a não trocar os produtos, o que pode provocar maus funcionamentos e danos à máquina de lavar louça.

Não misture detergentes diversos, o dispositivo doseador pode-se danificar. Os detergentes para máquinas industriais podem provocar graves irritações. Respeite atentamente as instruções do produtor de detergente descritos na embalagem.

Abra a torneira de rede da água (utilização)	Verifique:		Active o interruptor geral (utilização), no visor, aparece "OFF".
	O nível de detergente e abrillantador nas embalagens	A posição correcta dos filtros, a rotação dos braços, a ausência de corpos estranhos na máquina de lavar louça.	
			

(\* ) A duração ciclos acima indicada refere-se a ligação trifásica, com alimentação com água quente a 50° C. Em caso de alimentação com água fria a duração dos ciclos pode aumentar em relação à temperatura da água em entrada.

## 6.2 Carregamento da louça

### Pratos

O cesto pode conter **12 pratos fundos** ou **18 pratos planos**. Retire os resíduos sólidos dos pratos (ossos, cascas, caracos, etc.); deixe preventivamente de molho em água fria os pratos com resíduos secos de queijo, ovo... etc.

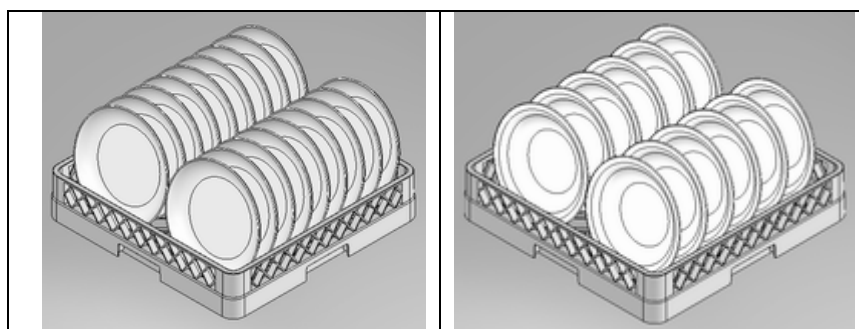

### Copos











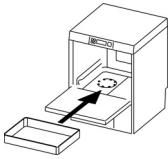

Posicione os copos virados para baixo.

### Talheres

Utilize o cesto/s apropriados. Disponha os talheres ao contrário de preferência com a pega virada para baixo, tomando atenção a não se ferir com as pontas dos garfos e as lâminas das facas.



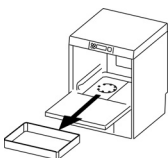

### 6.3 Primeira utilização diária (tanque e esquentador vazios) modelos mecanicos

O painel visualizado no manual e a gráfica poderão mostrar funções não presentes na vossa máquina.	Acção e o que sucede
	<p>Accionar o interruptor de parede, abrir a porta inserir o tubo ladrão, fechar a porta:</p> <p>Pressionar o botão <b>on/off</b> , a lâmpada de sinalização acende-se, carregamento de água no esquentador e no tanque. Ao carregar o esquentador e o tacque a lâmpada de sinalização esquentador acende-se. </p>
	<p>Carregar o cesto</p>
	<p>Selecione o programa desejado:</p> <p> Ciclo breve o</p> <p> Ciclo medio</p>
	<p>Esperar que a lâmpada de sinalização esquentador  se apague. Para ligar o ciclo de lavagem pressionar o botão ciclo </p>
	<p>Ciclo em curso, a lâmpada de sinalização ciclo acende-se. Se abrir a porta durante o ciclo o programa pára, quando é fechada novamente o programa zera-se; para ligar novamente pressionar o botão do ciclo </p>
	<p>Quando o programa termina a lâmpada de sinalização ciclo apaga-se e acender-se-á a lâmpada de sinalização esquentador .</p>
	<p>Descarregar o cesto</p>

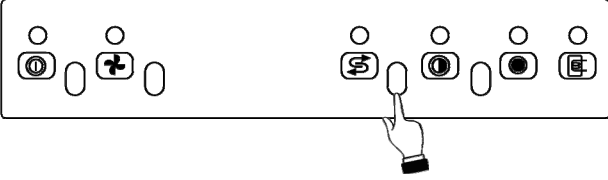

## 6.4 Passagem por água fria manual (sómente para os modelos provistos)

	<p>Com a máquina desligada abrir a porta e <b>retirar o tubo ladrão para esvaziar o tanque; uma vez esvaziado o tanque pôr novamente o tubo ladrão para esvaziar o tanque</b> e fechar a porta. Pressionar o botão : a lâmpada de sinalização acende-se e o ciclo de regeneração parte, após 20 minutos o ciclo de regeneração termina e a máquina mantém-se desligada. Abrir a porta, verificar que a água de regeneração esteja no tanque, retirar o tubo ladrão para esvaziar o tanque; uma vez esvaziado o tanque pôr novamente o tubo ladrão e fechar a porta. Desligar o interruptor geral de parede.</p>
---	--

Durante a execução do ciclo de regeneração não é possível efectuar qualquer operação, deve ser efectuada com o tanque vazio.

### Reforneamento de sal regenerante (para modelos provistos de amaciador de água)





Efectuar o reforneamento de sal **quando não existe água no tanque** para evitar que a água da lavagem entre no dispositivo amaciador de água; extrair sempre a ficha de alimentação da tomada de rede antes de efectuar a operação. Recordar-se de pôr novamente a ficha de alimentação na tomada após ter efectuado a operação.

### Atenção: usar sómente sal específico, não utilizar sal alimentar.

O reservatório de sal tem uma capacidade de cerca de **1 kg de sal em grão**.

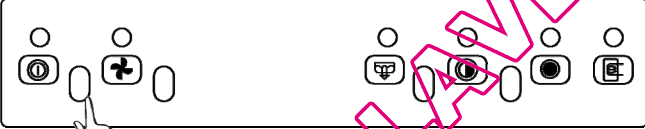
O reservatório está situado no fundo do tanque. Após ter extraído o cesto desapertar a tampa e verter o sal utilizando um funil em dotação. Antes de apertar novamente a tampa remover os eventuais resíduos de sal nas proximidades da abertura.

## 6.5 Scarico totale a fine giornata

	<p><b>Descarga total no fim do dia (modelos com a bomba de descarga)</b> Desligar a máquina pressionando o botão <b>on/off</b> , abrir a porta e retirar o tubo ladrão, mantendo pressionado o botão bomba de descarga  até ao completo esvaziamento do tanque. Para fazer tornar a máquina novamente operativa portanto é necessário pôr novamente o tubo ladrão no tanque fechar a porta e pressionar o botão <b>on/off</b> , ou no caso de fim de serviço, desligar o interruptor geral da parede.</p> <p><b>Descarga total no fim do dia (modelos sem a bomba de descarga)</b> Desligar a máquina pressionando o botão <b>on/off</b> , abrir a porta e retirar o tubo ladrão, e esperar o completo esvaziamento do tanque. Pôr novamente o tubo ladrão e fechar a porta. Desligar o interruptor geral da parede.</p>
---	--

Não desligar a máquina com água no tanque, efectuar sempre a descarga. No fim do serviço, após ter efectuado a descarga final e a eventual regeneração desligar a máquina pressionando o interruptor



**on/off** , desligar o interruptor da parede e fechar a torneira de intercepção da água. Não deixar a máquina inactiva acesa e inutilizada por períodos de tempo mais ao menos longos.

## 7 MANUTENÇÃO E LIMPEZA

Mesmo que não seja requerida uma particular manutenção programada aconselhamos de fazer controlar a máquina de lavar loiça a um técnico especializado duas vezes por ano.

**N.B:** danos intencionais ou derivantes do descuido, da negligência, da inobservância das prescrições, instruções e normas ou de ligações erradas, não devem ser da responsabilidade do construtor.

### 7.1 Limpeza quotidiana

A máquina responde ao grau de protecção **IPX4**, mas é **proibido** utilizar jactos de água directos para a limpeza.

#### LIMPEZA DO FILTRO DURANTE O DIA

Aconselha-se, no caso de utilização particularmente gravosa, efectuar em cada 30-40 ciclos a limpeza do filtro, mantendo a máquina em condições operativas; para fazer isso efectuar a “descarga parcial do tanque”.

Remover os filtros (é suficiente elevá-los da sua sede conforme indicado na figura), tendo atenção que os resíduos pesados não caiam no poço por baixo dos filtros, limpá-los dos resíduos e enxaguar os mesmos abundantemente, inserindo-os de novo correctamente; não utilizar objectos pontiagudos ou cortantes.

Limpar eventuais incrustações de calcário para evitar acumulações;

- Limpar com cuidado e frequentemente as superfícies com um pano húmido; usar detergentes neutros, não abrasivos, que não contenham substâncias á base de cloro, produtos que corroem e danificam o aço inóx.

Não utilizar os produtos elencados nem para limpar o pavimento por baixo da máquina ou nas proximidades, para evitar que o vapor ou gotas possam produzir danos ás superfícies em aço.

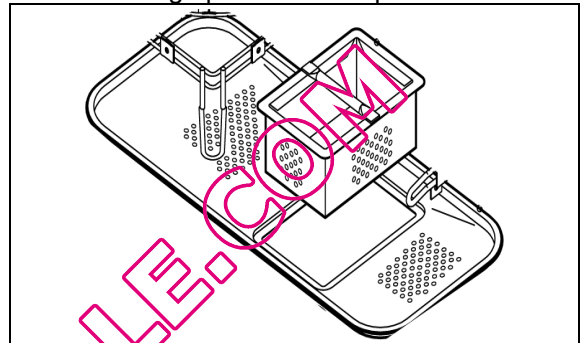

### 7.2 Controles periódicos

Desmontar os aspersores (inferior e superior 2-4), desapertando o parafuso central (4); desapertar a tampa das duas extremidades dos aspersores de lavagem (7).

Limpar os orifícios e os injectores por baixo de um jacto de água corrente limpa, não usar apetrechos que podem provocar danos. Montar novamente os aspersores com cuidado.

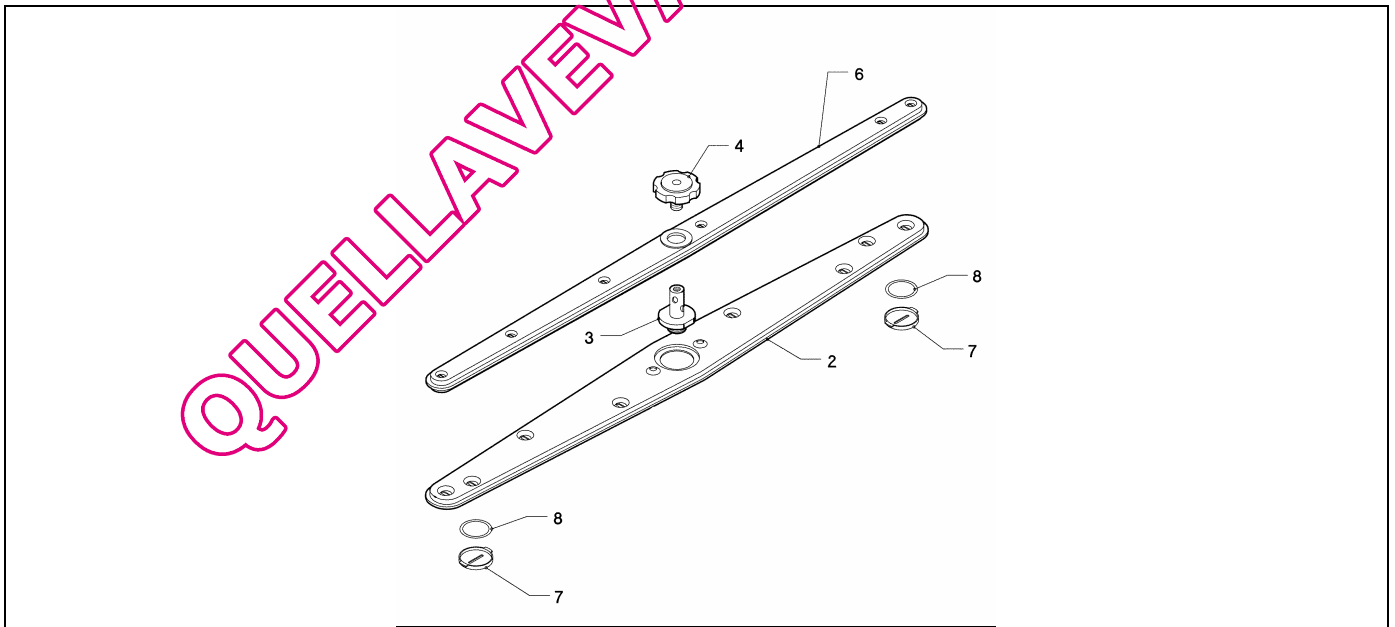

Limpar externamente a máquina com um pano húmido e sabão neutro enxaguando e secando attentamente.

### 7.3 Paragem prolongada

Se se prevê a não utilização da máquina por um período de tempo muito longo, **é necessário efectuar o esvaziamento do dispositivo fornecimento de detergente e abrillantante para evitar cristalizações e danos nas bombas:** Retirar os tubos de imersão dos recipientes do detergente e abrillantante e imergir-los num recipiente que contém água limpa, efectuar alguns ciclos de lavagem, efectuar a descarga completa.

Finalmente desligar o interruptor geral, fechar a torneira de entrada de água, os tubos de imersão do detergente e abrillantante devem ser novamente inseridos nos recipientes no momento da entrada em funcionamento, **prestando atenção para não inverter os mesmos ( tubo vermelho rosso = detergente; tubo transparente = abrillantante).**

**Não deixar a máquina inactiva acesa por períodos de tempo mais ou menos longos.**



## 8 PROBLEMAS E ANOMALIAS (UTENTE)



PROBLEMA	POSSÍVEL CAUSA	POSSÍVEL SOLUÇÃO
A LUZ DE SINALIZAÇÃO DE LINHA NÃO SE ACENDE	Falta tensão de rede	Verificar ligações á rede eléctrica.
O PROGRAMA DE LAVAGEM NÃO ARRANCA	O enchimento da máquina ainda não terminou.	Esperar que a lâmpada de sinalização esquentador se acenda.
OS RESULTADOS DE LAVAGEM NÃO SÃO SATISFATÓRIOS	Orifícios dos aspersores de lavagem entupidos ou incrustados	Desmontar e limpar os aspersores (10.2 Controles periódicos)
	Detergente ou abrillantante insuficiente ou não adequado	Verificar o tipo e quantidade de detergente.
	Pratos /copos mal posicionados	Dispôr adequadamente os pratos/copos.
	Baixa temperatura de lavagem	Verificar a temperatura visualizada no display, se fôr inferior aos 50° contactar a Assistência.
	Ciclo programado inadequado	Aumentar a duração do ciclo de lavagem, em particular se estiver muito sujo ou parcialmente ressequido
PASSAGEM POR ÁGUA INSUFICIENTE	Injectores aspersores entupidos Esquentador incrustado de calcário	Verificar a limpeza dos injectores e se o amaciador eventualmente montado funciona correctamente.
COPOS E TALHERES MANCHADOS	Abrillantante inadequado ou não fornecido correctamente. Dureza da água superior a 12°dF ou muitos sais espalhados	Verificar o recipiente abrillantante e se fôr adequado ao tipo de água da rede. Se o problema permaner contactar a assistência.
PRESENÇA DE ÁGUA NO TANQUE APOS A DESCARGA	Tubo de descarga mal posicionado ou parcialmente obstruido	Verificar se o tubo e a descarga da máquina não estejam obstruidos e que a descarga não esteja posicionada muito no alto; vêr esquema de ligação.